

Lenovo ThinkSystem SR635 Server Product Guide

The Lenovo ThinkSystem SR635 is a 1-socket 1U server that features the AMD EPYC 7002 "Rome" and AMD EPYC 7003 "Milan" families of processors. With up to 64 cores per processor and support for the PCIe 4.0 standard for I/O, the SR635 offers the ultimate in single-socket server performance in a space-saving 1U form factor. With up to 128 PCIe lanes, the server is ideal for dense workloads that can take advantage of GPU processing and high-performance NVMe drives.

Suggested uses: AI Inference, VDI, OLTP, Analytics, HPC, software-defined storage



Figure 1. Lenovo ThinkSystem SR635

Did you know?

By using a high-performance server with only one processor installed, you can take advantage of lower software costs when the software licensing is using a per-socket model. In addition, The server offers onboard NVMe PCIe ports that allow direct connections to 16x NVMe SSDs, which frees up I/O slots and helps lower NVMe solution acquisition costs.

The SR635 has been designed to take advantage of the features of the EPYC 7002 and 7003 processors, such as the full performance of 280W 64-core processors, support for 3200 MHz memory and PCIe Gen 4.0 support. Competitive servers that are based on the older EPYC 7001 "Naples" designs may not be able to offer these performance features.

Key features

Combining performance and flexibility, the SR635 server is a great choice for enterprises of all sizes. The server offers a broad selection of drive and slot configurations and offers high performance features that industries such as finance, healthcare and telco need. Outstanding reliability, availability, and serviceability (RAS) and high-efficiency design can improve your business environment and can help save operational costs.

Scalability and performance

The SR635 offers numerous features to boost performance, improve scalability and reduce costs:

- Supports the AMD EPYC 7002 and EPYC 7003 families family of processors
- Supports processors with up to 64 cores and 128 threads, core speeds of up to 4.1 GHz, and TDP ratings of up to 280W.
- Support for up to 16 TruDDR4 memory DIMMs, with 8 memory channels and 2 DIMMs per channel. With 1 DIMM installed per channel (8 DIMMs total), memory operates at up to 3200 MHz. With 2 DIMMs per channel (16 DIMMs total), memory operating at up to 2933 MHz.
- Using 128GB DIMMs, the server supports up to 2TB of system memory.
- Supports up to three single-width GPUs, each up to 75W. A 3:1 ratio of GPUs to CPUs means substantial processing power is available with just one CPU.
- Supports up to 16x 2.5-inch hot-swap drive bays, by using combinations of front-accessible (up to 10 bays), mid-accessible (4 bays), and rear-accessible (2 bays).
- Supports four 3.5-inch drive bays for lower-cost high-capacity storage. 2.5-inch and 3.5-inch drive bays can be mixed in several combinations.
- Supports 16x NVMe drives without oversubscription of PCIe lanes (1:1 connectivity) and without the need for additional NVMe adapters. The use of NVMe drives maximizes drive I/O performance, in terms of throughput, bandwidth, and latency.
- Supports 12x SATA drives using the onboard SATA controller (no additional adapter needed), enabling lower cost, high capacity storage solution for cold storage workloads.
- Supports 12x SAS drives using a variety of support RAID controllers or SAS HBAs.
- Supports high-speed RAID controllers from Broadcom providing 12 Gb SAS connectivity to the drive backplanes. A variety of RAID adapters are available, with cache and support for 16 drives on a single controller.
- Supports M.2 drives for convenient operating system boot functions or data storage. Available M.2 adapters support either one M.2 drive or two M.2 drives in a RAID 1 configuration for performance and reliability.
- The server has a dedicated industry-standard OCP 3.0 small form factor (SFF) slot, with a PCIe 4.0 x16 interface, supporting a variety of Ethernet network adapters. Simple-swap mechanism with thumbscrews and pull-tab enables tool-less installation and removal of the adapter. Supports shared BMC network sideband connectivity to enable out-of-band systems management.
- The server offers PCI Express 4.0 I/O expansion capabilities that doubles the theoretical maximum bandwidth of PCIe 3.0 (16GT/s in each direction for PCIe 4.0, compared to 8 GT/s with PCIe 3.0). A PCIe 4.0 x16 slot provides 64 GB/s bandwidth, enough to support a 400GbE network connection.
- A total of up to four PCIe 4.0 slots (3 with rear access, 1 internal for a RAID adapter) plus a slot dedicated to the OCP adapter.

Availability and serviceability

The SR635 provides many features to simplify serviceability and increase system uptime:

- The server uses ECC memory and supports memory RAS features including Single Device Data Correction (SDDC, also known as Chipkill), Patrol/Demand Scrubbing, DRAM Address Command Parity with Replay, and DRAM Uncorrected ECC Error Retry.
- The server offers hot-swap drives, supporting RAID redundancy for data protection and greater system uptime.
- The M.2 SATA RAID Boot Adapter supports RAID-1 which enables two installed M.2 drives to be configured as a redundant pair.
- The server has up to two hot-swap redundant power supplies and seven hot-swap redundant fans to provide availability for business-critical applications.
- The power-source-independent light path diagnostics uses LEDs to lead the technician to failed (or failing) components, which simplifies servicing, speeds up problem resolution, and helps improve system availability.
- Solid-state drives (SSDs) offer more reliability than traditional mechanical HDDs for greater uptime.
- The built-in ASPEED AST2500 baseboard management controller (BMC) continuously monitors system parameters, triggers alerts, and performs recovery actions in case of failures to minimize downtime.
- Proactive Platform Alerts: Voltage regulators, memory, fans, power supplies, server ambient and subcomponent temperatures. Alerts can be surfaced through the BMC to managers such as Lenovo XClarity Administrator. These proactive alerts let you take appropriate actions in advance of possible failure, thereby increasing server uptime and application availability.
- Web-based ThinkSystem System Manager (TSM) provides remote access to the BMC for remote management.
- Lenovo XClarity Provisioning Manager Lite (LXPM Lite) tool can be used to install an operating system on the server and perform system diagnostics.
- Three-year or one-year customer-replaceable unit and onsite limited warranty, 9 x 5 next business day. Optional service upgrades are available.

Manageability and security

Systems management features simplify local and remote management of the SR635:

- Supports Lenovo XClarity Provisioning Manager Lite (LXPM Lite) for system setup and firmware upgrades.
- An integrated industry-standard Unified Extensible Firmware Interface (UEFI) enables improved setup, configuration, and updates, and simplifies error handling.
- Support for industry standard management protocols, IPMI 2.0, SNMP 3.0, Redfish REST API, serial console via IPMI
- An integrated hardware Trusted Platform Module (TPM) supporting TPM 2.0 enables advanced cryptographic functionality, such as digital signatures and remote attestation.
- Administrator and power-on passwords help protect from unauthorized access to the server.
- Support for Lenovo XClarity Energy Manager, which captures real-time power and temperature data from the server and integrates with Redfish-based applications to provide automated controls to lower energy costs.
- Supports AMD Secure Root-of-Trust, Secure Run and Secure Move features to minimize potential attacks and protect data as the OS is booted, as applications are run and as applications are migrated from server to server.
- Supports Secure Boot to ensure only a digitally signed operating system can be used.

- Industry-standard Advanced Encryption Standard (AES) NI support for faster, stronger encryption.

Energy efficiency

The SR635 offers the following energy-efficiency features to save energy, reduce operational costs, and increase energy availability:

- Energy-efficient planar components help lower operational costs.
- High-efficiency power supplies with 80 PLUS Platinum and Titanium certifications
- Low-voltage 1.2 V DDR4 memory offers energy savings compared to 1.35 V and 1.5 V DDR3 DIMMs.
- Solid-state drives (SSDs) consume as much as 80% less power than traditional spinning 2.5-inch HDDs.
- The server uses hexagonal ventilation holes, which can be grouped more densely than round holes, providing more efficient airflow through the system and thus keeping your system cooler.
- Optional Lenovo XClarity Energy Manager provides advanced data center power notification and analysis to help achieve lower heat output and reduced cooling needs.

Components and connectors

The following figure shows the front of the server.

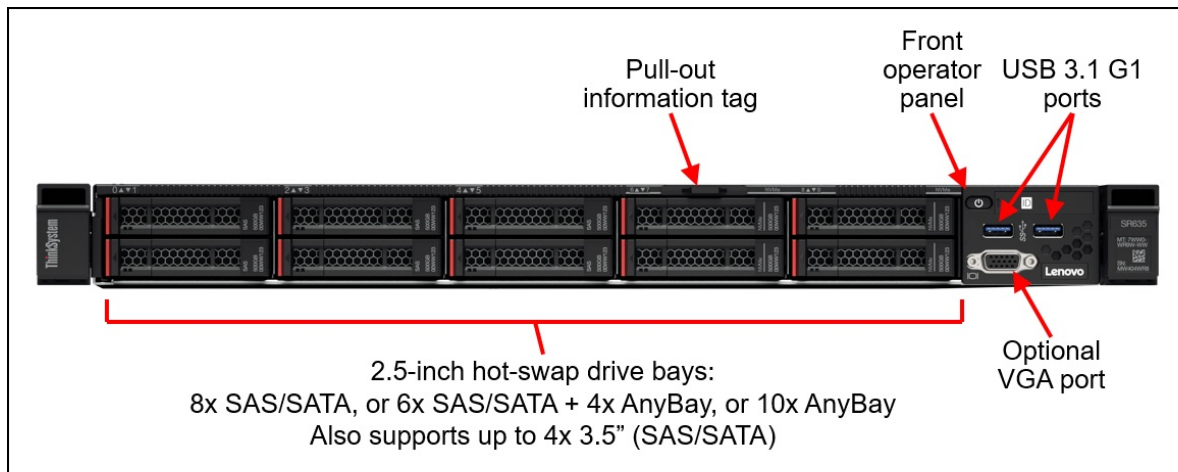

Figure 2. Front view of the Lenovo ThinkSystem SR635

The following figure shows the components visible from the rear of the server. As shown, there are three different configurations available

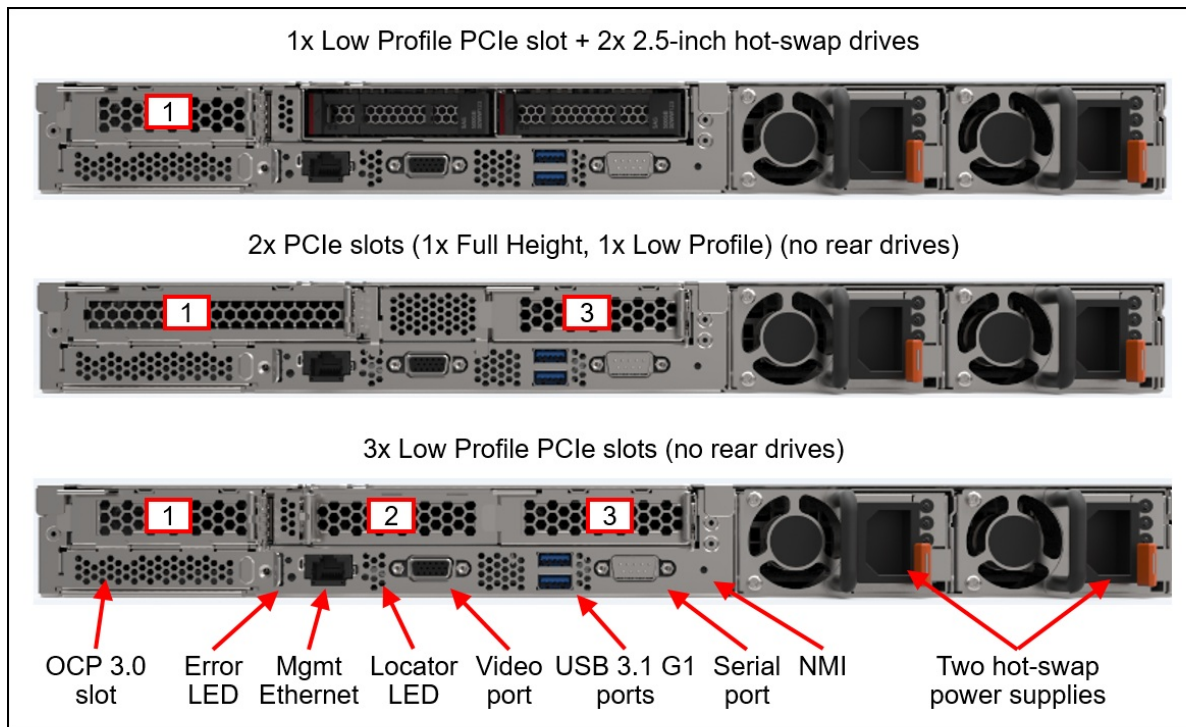

Figure 3. Rear view of the Lenovo ThinkSystem SR635

The following figure shows the locations of key components inside the server.

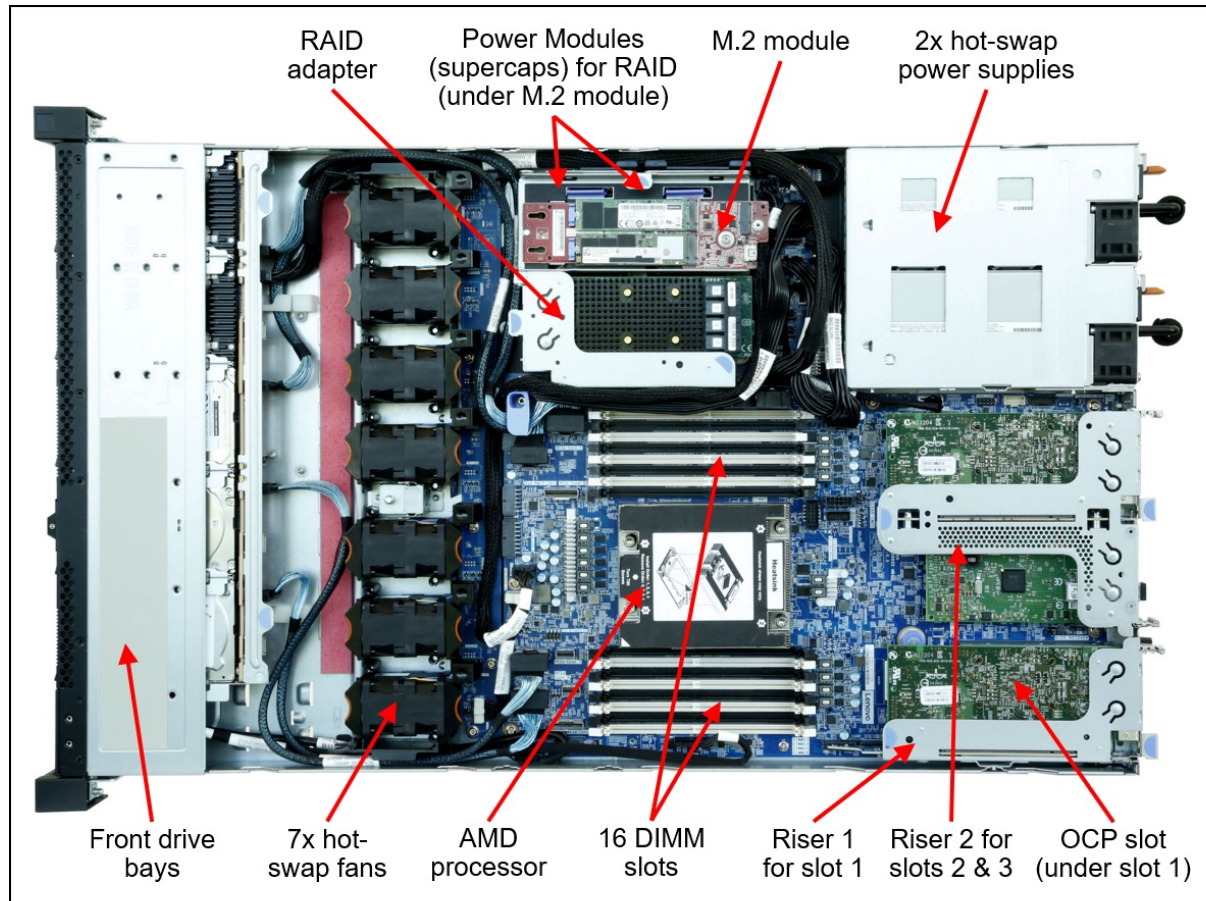

Figure 4. Internal view of the Lenovo ThinkSystem SR635

System architecture

The following figure shows the architectural block diagram of the SR635, showing the major components and their connections.

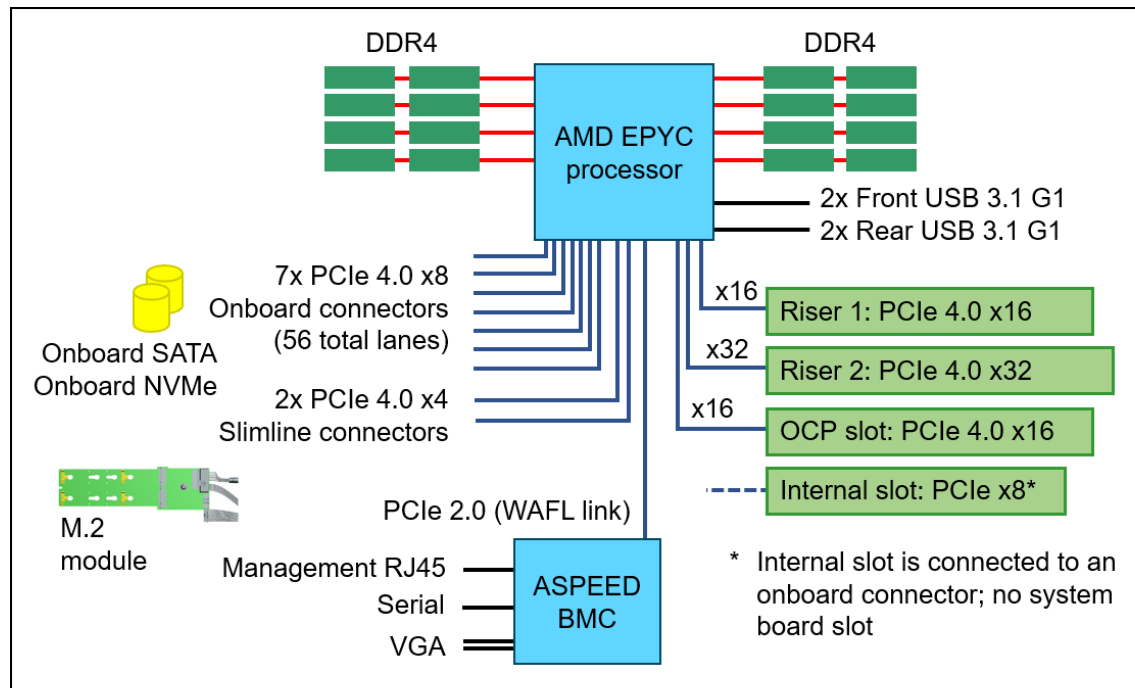

Figure 5. SR635 system architectural block diagram

Standard specifications

The following table lists the standard specifications.

Table 1. Standard specifications

Components	Specification
Machine types	7Y98 - 1 year warranty 7Y99 - 3 year warranty
Form factor	1U rack.
Processor	One AMD EPYC 7002 Series processor (formerly codenamed "Rome") or AMD EPYC 7003 Series processors (formerly codenamed "Milan"). Supports processors up to 64 cores, core speeds of up to 4.1 GHz, and TDP ratings of up to 280W.
Memory	16 DIMM slots. The processor has 8 memory channels, with 2 DIMMs per channel. Lenovo TruDDR4 RDIMMs are supported. DIMMs are available in two speeds: 3200 MHz and 2933 MHz. With 3200 MHz memory, the server supports a 3200 MHz memory bus speed at 1 DIMM per channel (DPC) and 2933 MHz at 2 DPC. With 2933 MHz memory, the server supports a 2933 MHz memory bus speed at both 1 and 2 DPC.
Memory maximum	Up to 2TB with 16x 128GB 3DS RDIMMs
Persistent memory	Not supported.
Memory protection	ECC, SDDC, Patrol/Demand Scrubbing, DRAM Address Command Parity with Replay, DRAM Uncorrected ECC Error Retry, Post Package Repair

Components	Specification
Disk drive bays	<p>Up to 4x 3.5-inch or 16x 2.5-inch hot-swap drive bays:</p> <ul style="list-style-type: none"> ● Front bays can be one of the following: <ul style="list-style-type: none"> ○ 4x 3.5-inch hot-swap SAS/SATA ○ 8x 2.5-inch hot-swap SAS/SATA ○ 6x 2.5-inch hot-swap SAS/SATA + 4x 2.5-inch hot-swap AnyBay ○ 10x 2.5-inch hot-swap AnyBay ● Mid (internal): 4x 2.5-inch hot-swap NVMe bays ● Rear can be one of the following: <ul style="list-style-type: none"> ○ 2x 2.5-inch hot-swap SAS/SATA bays ○ 2x 2.5-inch hot-swap NVMe bays <p>See Supported drive bay combinations for details. AnyBay bays support SAS, SATA or NVMe drives. NVMe bays only support NVMe drives. Both mid and rear drive bays can be used in conjunction with 2.5-inch front drive bays. Mid bays are hot-swap drive bays and are accessible by removing the top cover of the server. The server supports up to 16x NVMe drives (10 front, 4 mid, 2 rear) all with direct connections (no oversubscription).</p>
Maximum internal storage	<ul style="list-style-type: none"> ● 2.5-inch drives: <ul style="list-style-type: none"> ○ 368.64TB using 12x 30.72TB 2.5-inch SAS/SATA SSDs ○ 307.2TB using 10x 30.72TB 2.5-inch NVMe SSDs ○ 24TB using 12x 2TB 2.5-inch HDDs ● 3.5-inch drives: <ul style="list-style-type: none"> ○ 88TB using 4x 22TB 3.5-inch HDDs ○ 61.44TB using 4x 15.36TB 3.5-inch SAS/SATA SSDs
Storage controller	<ul style="list-style-type: none"> ● Onboard SATA supporting up to 12 SATA drives (no RAID) ● 12 Gb SAS/SATA RAID adapters ● 12 Gb SAS/SATA non-RAID
Optical drive bays	No internal optical drive.
Tape drive bays	No internal backup drive.
Network interfaces	Dedicated OCP 3.0 SFF slot with PCIe 4.0 x16 host interface. Supports a variety of 2-port and 4-port adapters with 1GbE, 10GbE and 25GbE network connectivity. One port can optionally be shared with the ASPEED management processor for Wake-on-LAN and NC-SI support.
PCI Expansion slots	<p>A total of up to 4 PCIe 4.0 slots (3 with rear access, 1 internal for a RAID adapter) plus a slot dedicated to the OCP adapter. Slot availability is based on riser selection.</p> <p>Three choices for rear-access slots:</p> <ul style="list-style-type: none"> ● 3x PCIe 4.0 x16 low-profile slots ● 1x PCIe 4.0 x16 full-height half-length slot + 1x PCIe 4.0 x16 low-profile slot ● 1x PCIe 4.0 x16 low-profile slot (supports 2x rear 2.5-inch drive bays) <p>Optionally, an additional internal PCIe 4.0 x8 low-profile slot for an internal drive controller.</p>

Components	Specification
Ports	<p>Front: Two USB 3.1 G1 (5 Gb/s) ports, optional VGA port.</p> <p>Rear: USB 3.1 G1 (5 Gb/s) ports, one VGA video port, one DB-9 serial port, and one RJ-45 1GbE systems management port.</p> <p>Internal: Optional M.2 module supporting up to two M.2 drives (for OS boot and drive storage support; not available in all configurations).</p>
Cooling	Six or seven N+1 redundant dual-rotor hot swap 40 mm fans, configuration dependent. One fan integrated in each power supply.
Power supply	Up to two hot-swap redundant AC power supplies (all 80 PLUS Platinum certification): 550 W, 750 W, 1100 W and 1600 W AC options, supporting 220 V AC. 550 W, 750 W and 1100 W options also support 110V input supply. In China only, all power supply options support 240 V DC.
Video	Onboard graphics with 512 MB memory with 2D hardware accelerator, integrated into the ASPEED AST2500 BMC management processor. Maximum resolution is 1920x1200 at 60Hz, 32bpp
Hot-swap parts	Drives, power supplies, and fans.
Systems management	ASPEED AST2500 embedded management processor, XClarity Provisioning Manager Lite (LXPM Lite) for system setup and firmware upgrades. XClarity Administrator centralized infrastructure management, and XClarity Energy Manager centralized server power management. Light path diagnostics for local failure detection and reporting.
Security features	Power-on password, administrator's password, Trusted Platform Module (TPM), supporting TPM 2.0. In China only, optional Nationz TPM 2.0. Optional lockable front security bezel. Optional chassis intrusion switch.
Operating systems supported	Microsoft Windows Server, Red Hat Enterprise Linux, SUSE Linux Enterprise Server, VMware ESXi. See the Operating system support section for specifics.
Limited warranty	Three-year or one-year (model dependent) customer-replaceable unit and onsite limited warranty with 9x5 next business day (NBD).
Service and support	Optional service upgrades are available through Lenovo Services: 4-hour or 2-hour response time, 6-hour fix time, 1-year or 2-year warranty extension, software support for Lenovo hardware and some third-party applications.
Dimensions	Width: 440 mm (17.3 in.), height: 43 mm (1.7 in.), depth: 755 mm (29.7 in.). See Physical and electrical specifications for details.
Weight	Maximum: 19.2 kg (42.3 lb)

Models

ThinkSystem SR635 models can be configured by using the [Lenovo Data Center Solution Configurator \(DCSC\)](#).

Configure-to-order (CTO) models are used to create models with factory-integrated server customizations. For CTO models, two base CTO models are available for the SR635 as listed in the following table, CTO1WW and CTOLWW:

- The CTO1WW base CTO model is for general business and is selectable by choosing **General Purpose** mode in DCSC.
- The CTOLWW base model is intended for High Performance Computing (HPC) and Artificial Intelligence (AI) configurations and solutions, including configurations for Lenovo Scalable Infrastructure (LeSI), and is enabled using either the **HPC & AI LeSI Solutions** mode or **HPC & AI Hardware** mode in DCSC. CTOLWW configurations can also be built using [System x and Cluster Solutions Configurator \(x-config\)](#).

Preconfigured server models may also be available for the SR635, however these are region-specific; that is, each region may define their own server models, and not all server models are available in every region.

The following table lists the base CTO models of the ThinkSystem SR635 server.

Table 2. Base CTO models

Machine Type/Model General purpose	Machine Type/Model for HPC and AI	Description
7Y99CTO1WW	7Y99CTOLWW	ThinkSystem SR635 – 3-year Warranty
7Y98CTO1WW	7Y98CTOLWW	ThinkSystem SR635 – 1-year Warranty

Models of the SR635 are defined based on whether the server has 2.5-inch drive bays at the front (called the 10x 2.5" chassis or simply the 2.5-inch chassis) or whether it has 3.5-inch drive bays at the front (called the 4x 3.5" chassis or simply the 3.5-inch chassis). For models, the feature codes for these chassis bases are as listed in the following table.

Table 3. Chassis base feature codes

Feature code	Description
B5VL	ThinkSystem SR635 10x2.5" Chassis
B5VM	ThinkSystem SR635 4x3.5" Chassis

The following tables list the available models, grouped by region.

- [Models for Australia and New Zealand](#)
- [Models for Brazil](#)
- [Models for EMEA countries](#)
- [Models for Hong Kong, Taiwan, Korea \(HTK\)](#)
- [Models for Japan](#)
- [Models for Latin American countries \(except Brazil\)](#)
- [Models for USA and Canada](#)

Refer to the Specifications section for information about standard features of the server.

Models for Australia and New Zealand

Table 4. Models for Australia and New Zealand

Model	AMD EPYC processor†	Memory	RAID	Drive bays	OCP	Slots*	Power supplies (cords)	Front VGA	Fans	Rail kit
TopSeller models with a 3-year model (machine type 7Y99)										
7Y99A029AU	7232P 8C 120W 3.1G	1x 32GB 3200	930-8i	8x 2.5" SAS Open bay	Open	3x LP x16 / 1	1x 750W HS (Y)	Yes	7x Std	Slide
7Y99A02CAU	7232P 8C 120W 3.1G	1x 32GB 3200	Onboard AHCI	8x 2.5" SAS Open bay	Open	3x LP x16 / 1	1x 750W HS (Y)	Yes	7x Std	Slide
7Y99A02AAU	7282 16C 120W 2.4G	1x 32GB 3200	Onboard AHCI	8x 2.5" SAS Open bay	Open	3x LP x16 / 1	1x 750W HS (Y)	Yes	7x Std	Slide
7Y99A02BAU	7282 16C 120W 2.4G	1x 32GB 3200	930-8i	8x 2.5" SAS Open bay	Open	3x LP x16 / 1	1x 750W HS (Y)	Yes	7x Std	Slide

† Processor description: AMD EPYC model, number of cores, thermal design power (TDP), core frequency

* Slots are listed as (x / y) where x = rear-accessible slots, y = internal slot)

Models for Brazil

Table 6. Models for Brazil

Model	AMD EPYC processor†	Memory	RAID	Drive bays	OCP	Slots*	Power supplies (cords)	Front VGA	Fans	Rail kit
Standard models with a 3-year model (machine type 7Y99)										
7Y99A01GBR	7262 8C 155W 3.2G	1x 16GB 2933	530-8i	8x 2.5" SAS Open bay	4x1Gb 5719	3x LP x16 / 0	1x 750W HS (Y)	Yes	6x Std	Slide
7Y99A01HBR	7302P 16C 155W 3.0G	1x 16GB 2933	530-8i	8x 2.5" SAS Open bay	4x1Gb 5719	3x LP x16 / 0	1x 750W HS (Y)	Yes	6x Std	Slide
7Y99A01JBR	7302P 16C 155W 3.0G	1x 32GB 2933	730-8i 1GB	8x 2.5" SAS Open bay	4x1Gb 5719	3x LP x16 / 0	1x 750W HS (Y)	Yes	6x Std	Slide

† Processor description: AMD EPYC model, number of cores, thermal design power (TDP), core frequency

* Slots are listed as (x / y) where x = rear-accessible slots, y = internal slot)

Models for EMEA countries

Table 7. Models for EMEA countries

Model	AMD EPYC processor†	Memory	RAID	Drive bays	OCP	Slots*	Power supplies (cords)	Front VGA	Fans	Rail kit
Standard models with a 3-year model (machine type 7Y99)										
Models with third-generation AMD EPYC processors										
7Y99A032EA	7313P 16C 155W 3.0G	1x 32GB 3200	940-8i 4G	8x 2.5" SAS Open bay	Open	3x LP x16 / 1	1x 750W HS (Y)	Yes	7x Std	Slide
7Y99A031EA	7343 16C 190W 3.2G	1x 32GB 3200	940-8i 4G	8x 2.5" SAS Open bay	Open	3x LP x16 / 1	1x 750W HS (Y)	Yes	7x Perf	Slide
7Y99A030EA	7453 28C 225W 2.8G	1x 32GB 3200	940-8i 4G	8x 2.5" SAS Open bay	Open	3x LP x16 / 1	1x 750W HS (Y)	Yes	7x Perf	Slide
7Y99A02ZEA	7543P 32C 225W 2.8G	1x 32GB 3200	940-8i 4G	8x 2.5" SAS Open bay	Open	3x LP x16 / 1	1x 750W HS (Y)	Yes	7x Perf	Slide
7Y99A02YEA	7713P 64C 225W 2.0G	1x 32GB 3200	940-8i 4G	8x 2.5" SAS Open bay	Open	3x LP x16 / 1	1x 750W HS (Y)	Yes	7x Perf	Slide

† Processor description: AMD EPYC model, number of cores, thermal design power (TDP), core frequency

* Slots are listed as (x / y) where x = rear-accessible slots, y = internal slot)

Models for Hong Kong, Taiwan, Korea (HTK)

Table 8. Models for Hong Kong, Taiwan, Korea (HTK)

Model	AMD EPYC processor†	Memory	RAID	Drive bays	OCP	Slots*	Power supplies (cords)	Front VGA	Fans	Rail kit
TopSeller models with a 3-year model (machine type 7Y99)										
7Y991002CN	7302P 16C 155W 3.0G	1x 32GB 3200	730-8i 2GB	8x 2.5" SAS Open bay	4x1Gb 5719	1x FH x16 / 0	2x 750W HS (Y)	Yes	6x Std	Fric
7Y99A033CN	7402P 24C 180W 2.8G	1x 32GB 3200	730-8i 2GB	8x 2.5" SAS Open bay	4x1Gb 5719	1x FH x16 / 0	2x 750W HS (Y)	Yes	6x Perf	Fric
7Y991003CN	7502P 32C 180W 2.5G	1x 32GB 3200	730-8i 2GB	8x 2.5" SAS Open bay	4x1Gb 5719	1x FH x16 / 0	2x 750W HS (Y)	Yes	6x Perf	Fric
7Y991004CN	7702P 64C 200W 2.0G	1x 32GB 3200	730-8i 2GB	8x 2.5" SAS Open bay	4x1Gb 5719	1x FH x16 / 0	2x 750W HS (Y)	Yes	6x Perf	Fric

† Processor description: AMD EPYC model, number of cores, thermal design power (TDP), core frequency

* Slots are listed as (x / y) where x = rear-accessible slots, y = internal slot)

Models for Japan

Table 10. Models for Japan

Model	AMD EPYC processor†	Memory	RAID	Drive bays	OCP	Slots*	Power supplies (cords)	Front VGA	Fans	Rail kit
TopSeller models with a 3-year model (machine type 7Y99)										
7Y99A01BJP	72628C 155W 3.2G	1x 16GB 3200	530-8i	8x 2.5" SAS Open bay	4x1Gb 5719	1x FH x16 / 0	1x 750W HS (N)	Yes	6x Std	Slide
7Y99A015JP	7302P 16C 155W 3.0G	1x 16GB 3200	530-8i	8x 2.5" SAS Open bay	4x1Gb 5719	1x FH x16 / 0	1x 750W HS (N)	Yes	6x Std	Slide
7Y99A019JP	7502P 32C 180W 2.5G	1x 16GB 3200	730-8i 2GB	8x 2.5" SAS Open bay	4x1Gb 5719	1x FH x16 / 0	1x 750W HS (N)	Yes	6x Perf	Slide
7Y99A01DJP	7702P 64C 200W 2.0G	1x 16GB 3200	730-8i 2GB	8x 2.5" SAS Open bay	4x1Gb 5719	1x FH x16 / 0	1x 750W HS (N)	Yes	6x Perf	Slide

† Processor description: AMD EPYC model, number of cores, thermal design power (TDP), core frequency

* Slots are listed as (x / y) where x = rear-accessible slots, y = internal slot)

Models for Latin American countries (except Brazil)

Table 11. Models with a 3-year warranty for Latin American countries (except Brazil)

Model	AMD EPYC processor†	Memory	RAID	Drive bays	OCP	Slots*	Power supplies (cords)	Front VGA	Fans	Rail kit
Standard models with a 3-year model (machine type 7Y99)										
Models with third-generation AMD EPYC processors										
7Y99A01PLA	7313P 16C 155W 3.0G	1x 32GB 3200	730-8i 1GB	8x 2.5" SAS Open bay	4x1Gb 5719	3x LP x16 / 0	1x 750W HS (Y)	Yes	6x Std	Slide
7Y99A034LA	7313P 16C 155W 3.0G	1x 16GB 3200	540-8i	8x 2.5" SAS Open bay	Open	Open / 1	1x 750W HS (Y)	Yes	7x Std	Slide CMA
Models with second-generation AMD EPYC processors										
7Y99A02ULA	7232P 8C 120W 3.1G	1x 16GB 2933	530-8i	4x 3.5" SAS Open bay	4x1Gb 5719	3x LP x16 / 0	1x 550W (Y)	Yes	6x Std	Slide
7Y991000LA	72628C 155W 3.2G	1x 16GB 3200	530-8i	8x 2.5" SAS Open bay	4x1Gb 5719	3x LP x16 / 0	1x 750W HS (Y)	Yes	6x Std	Slide
7Y99A01MLA	72628C 155W 3.2G	1x 16GB 2933	530-8i	8x 2.5" SAS Open bay	4x1Gb 5719	3x LP x16 / 0	1x 750W HS (Y)	Yes	6x Std	Slide
7Y99A02TLA	7272 12C 120W 2.6G	1x 16GB 2933	530-8i	4x 3.5" SAS Open bay	4x1Gb 5719	3x LP x16 / 0	1x 550W (Y)	Yes	6x Std	Slide
7Y991001LA	7302P 16C 155W 3.0G	1x 32GB 3200	530-8i	8x 2.5" SAS Open bay	4x1Gb 5719	3x LP x16 / 0	1x 750W HS (Y)	Yes	6x Std	Slide
7Y99A01NLA	7302P 16C 155W 3.0G	1x 16GB 2933	530-8i	8x 2.5" SAS Open bay	4x1Gb 5719	3x LP x16 / 0	1x 750W HS (Y)	Yes	6x Std	Slide

† Processor description: AMD EPYC model, number of cores, thermal design power (TDP), core frequency

* Slots are listed as (x / y) where x = rear-accessible slots, y = internal slot)

Models for USA and Canada

Table 12. Models for USA and Canada

Model	AMD EPYC processor†	Memory	RAID	Drive bays	OCP	Slots*	Power supplies (cords)	Front VGA	Fans	Rail kit
Standard models with a 3-year model (machine type 7Y99)										
7Y99A028NA	7282 16C 120W 2.4G	1x 16GB 3200	Option	Optional 2.5" Open bay	Open	Open / 0	1x 750W HS (Y)	Yes	6x Std	Slide
7Y99A01ANA	7302P 16C 155W 3.0G	1x 16GB 3200	Option	Optional 2.5" Open bay	Open	Open / 0	1x 750W HS (Y)	Yes	6x Std	Slide
7Y99A02WNA	7302P 16C 155W 3.0G	1x 32GB 3200	Option	Optional 2.5" Open bay	Open	Open / 0	1x 750W HS (Y)	Yes	6x Std	Slide
7Y99A016NA	7402P 24C 180W 2.8G	1x 32GB 3200	Option	Optional 2.5" Open bay	Open	Open / 0	1x 1100W HS (Y)	Yes	6x Perf	Slide
7Y99A02VNA	7402P 24C 180W 2.8G	1x 32GB 3200	Option	Optional 2.5" Open bay	Open	Open / 0	1x 1100W (Y)	Yes	6x Perf	Slide
7Y99A017NA	7502P 32C 180W 2.5G	1x 32GB 3200	Option	Optional 2.5" Open bay	Open	Open / 0	1x 1100W HS (Y)	Yes	6x Perf	Slide
7Y99A018NA	7702P 64C 200W 2.0G	1x 32GB 3200	Option	Optional 2.5" Open bay	Open	Open / 0	1x 1100W HS (Y)	Yes	6x Perf	Slide

† Processor description: AMD EPYC model, number of cores, thermal design power (TDP), core frequency

* Slots are listed as (x / y) where x = rear-accessible slots, y = internal slot)

Processors

The SR635 supports processors in the AMD EPYC family of processors. The server supports one processor.

- [Processor options](#)
- [Processor features](#)
- [UEFI operating modes](#)

Processor options

The table below lists the supported AMD processors.

All supported processors have the following characteristics:

- Third and second-generation AMD EPYC processors (formerly codenamed "Milan" and "Rome" respectively)
- 7 nm process technology
- Eight DDR4 memory channels
- 128 PCIe 4.0 I/O lanes

Part numbers: Processors do not include an option part number because there are no field upgrades supported.

Table 13. Processor options for the SR635

Feature code	Description
Third-generation AMD EPYC processors	
BF7H	ThinkSystem AMD EPYC 72F3 8C 180W 3.7GHz Processor
BF76	ThinkSystem AMD EPYC 7313 16C 155W 3.0GHz Processor

Feature code	Description
BF7B	ThinkSystem AMD EPYC 7313P 16C 155W 3.0GHz Processor
BF7E	ThinkSystem AMD EPYC 7343 16C 190W 3.2GHz Processor
BF7D	ThinkSystem AMD EPYC 73F3 16C 240W 3.5GHz Processor
BF78	ThinkSystem AMD EPYC 7413 24C 180W 2.65GHz Processor
BF72	ThinkSystem AMD EPYC 7443 24C 200W 2.85GHz Processor
BF79	ThinkSystem AMD EPYC 7443P 24C 200W 2.85GHz Processor
BF74	ThinkSystem AMD EPYC 7453 28C 225W 2.75GHz Processor
BF7G	ThinkSystem AMD EPYC 74F3 24C 240W 3.2GHz Processor
BF7A	ThinkSystem AMD EPYC 7513 32C 200W 2.6GHz Processor
BF77	ThinkSystem AMD EPYC 7543 32C 225W 2.8GHz Processor
BF71	ThinkSystem AMD EPYC 7543P 32C 225W 2.8GHz Processor
BF7F	ThinkSystem AMD EPYC 75F3 32C 280W 2.95GHz Processor
BGQ5	ThinkSystem AMD EPYC 7643 48C 225W 2.3GHz Processor
BF75	ThinkSystem AMD EPYC 7663 56C 240W 2.0GHz Processor
BF7C	ThinkSystem AMD EPYC 7713 64C 225W 2.0GHz Processor
BF70	ThinkSystem AMD EPYC 7713P 64C 225W 2.0GHz Processor
BF73	ThinkSystem AMD EPYC 7763 64C 280W 2.45GHz Processor
Second-generation AMD EPYC processors	
B766	ThinkSystem AMD EPYC 7232P 8C 120W 3.1GHz Processor
B6TS	ThinkSystem AMD EPYC 7262 8C 155W 3.2GHz Processor
B767	ThinkSystem AMD EPYC 7272 12C 120W 2.9GHz Processor
B6VZ	ThinkSystem AMD EPYC 7282 16C 120W 2.8GHz Processor
B6TV	ThinkSystem AMD EPYC 7302 16C 155W 3.0GHz Processor
B6VV	ThinkSystem AMD EPYC 7302P 16C 155W 3.0GHz Processor
BCE8	ThinkSystem AMD EPYC 7F52 16C 240W 3.5GHz Processor
B6W0	ThinkSystem AMD EPYC 7352 24C 155W 2.3GHz Processor
B6VW	ThinkSystem AMD EPYC 7402 24C 180W 2.8GHz Processor
B6TT	ThinkSystem AMD EPYC 7402P 24C 180W 2.8GHz Processor
BCEA	ThinkSystem AMD EPYC 7F72 24C 240W 3.2GHz Processor
B6TU	ThinkSystem AMD EPYC 7452 32C 155W 2.35 GHz Processor
B6VX	ThinkSystem AMD EPYC 7502P 32C 180W 2.5GHz Processor
BABP	ThinkSystem AMD EPYC 7532 32C 200W 2.4GHz Processor
B6W2	ThinkSystem AMD EPYC 7542 32C 225W 2.9GHz Processor
B6W3	ThinkSystem AMD EPYC 7642 48C 225W 2.3GHz Processor
B6VY	ThinkSystem AMD EPYC 7702P 64C 200W 2.0GHz Processor
BAVP	ThinkSystem AMD EPYC 7H12 64C 280W 2.6GHz Processor

Processor features

The following table lists the features of the supported processors.

P suffix: Processor models with a P suffix are designated as single-socket processors. They have identical features to the non-P equivalent processors.

The following table lists the features of the supported processors.

Table 14. Processor specifications

EPYC model**	Cores / Threads	Base Frequency	Max Boost Frequency†	L3 Cache	Memory channels	Memory bus	TDP
Third-generation AMD EPYC processors							
72F3	8 / 16	3.7 GHz	4.1 GHz	256 MB	8	3200 MHz	180 W
7313 / 7313P	16 / 32	3.0 GHz	3.7 GHz	128 MB	8	3200 MHz	155 W
7343	16 / 32	3.2 GHz	3.9 GHz	128 MB	8	3200 MHz	190 W
73F3	16 / 32	3.5 GHz	4.0 GHz	256 MB	8	3200 MHz	240 W
7413	24 / 48	2.65 GHz	3.6 GHz	128 MB	8	3200 MHz	180 W
7443 / 7443P	24 / 48	2.85 GHz	4.0 GHz	128 MB	8	3200 MHz	200 W
7453	28 / 56	2.75 GHz	3.45 GHz	64 MB	8	3200 MHz	225 W
74F3	24 / 48	3.2 GHz	4.0 GHz	256 MB	8	3200 MHz	240 W
7513	32 / 64	2.6 GHz	3.65 GHz	128 MB	8	3200 MHz	200 W
7543 / 7543P	32 / 64	2.8 GHz	3.7 GHz	256 MB	8	3200 MHz	225 W
75F3	32 / 64	2.95 GHz	4.0 GHz	256 MB	8	3200 MHz	280 W
7643	48 / 96	2.3 GHz	3.6 GHz	256 MB	8	3200 MHz	225 W
7663	56 / 112	2.0 GHz	3.5 GHz	256 MB	8	3200 MHz	225 W
7713 / 7713P	64 / 128	2.0 GHz	3.675 GHz	256 MB	8	3200 MHz	225 W
7763	64 / 128	2.45 GHz	3.5 GHz	256 MB	8	3200 MHz	280 W
Second-generation AMD EPYC processors							
7232P	8 / 16	3.1 GHz	3.2 GHz	32 MB	8	3200 MHz*	120 W
7262	8 / 16	3.2 GHz	3.4 GHz	128 MB	8	3200 MHz	155W
7272	12 / 24	2.9 GHz	3.2 GHz	64 MB	8	3200 MHz*	120 W
7282	16 / 32	2.8 GHz	3.2 GHz	64 MB	8	3200 MHz*	120 W
7302 / 7302P	16 / 32	3.0 GHz	3.3 GHz	128 MB	8	3200 MHz	155 W
7F52	16 / 32	3.5 GHz	3.9 GHz	256 MB	8	3200 MHz	240W
7352	24 / 48	2.3 GHz	3.2 GHz	128 MB	8	3200 MHz	155 W
7402 / 7402P	24 / 48	2.8 GHz	3.35 GHz	128 MB	8	3200 MHz	180 W
7F72	24 / 48	3.2 GHz	3.7 GHz	192 MB	8	3200 MHz	240W
7452	32 / 64	2.35 GHz	3.35 GHz	128 MB	8	3200 MHz	155 W
7502 / 7502P	32 / 64	2.5 GHz	3.35 GHz	128 MB	8	3200 MHz	180 W
7532	32 / 64	2.4 GHz	3.3 GHz	256 MB	8	3200 MHz	200W
7542	32 / 64	2.9 GHz	3.4 GHz	128 MB	8	3200 MHz	225 W
7642	48 / 96	2.3 GHz	3.3 GHz	256 MB	8	3200 MHz	225 W
7702 / 7702P	64 / 128	2.0 GHz	3.35 GHz	256 MB	8	3200 MHz	200 W
7H12	64 / 128	2.6 GHz	3.3 GHz	256 MB	8	3200 MHz	280W

- † The maximum single-core frequency at which the processor is capable of operating
- * This processor supports 8 memory channels at 3200 MHz, however performance is optimized for 4 channels at 2666 MHz
- ** Processors with a P suffix are single-socket capable processors

UEFI operating modes

The SR635 offers preset operating modes that affect energy consumption and performance. These modes are a collection of predefined low-level UEFI settings that simplify the task of tuning the server to suit your business and workload requirements.

The following table lists the feature codes that allow you to specify the mode you wish to preset in the factory for CTO orders.

Table 15. UEFI operating mode presets in DCSC

Feature code	Description
BFYA	Operating mode selection for: "Maximum Efficiency Mode"
BFYB	Operating mode selection for: "Maximum Performance Mode"

The preset modes for the SR635 are as follows:

- **Maximum Efficiency Mode** (feature BFYA): Maximizes performance/watt efficiency while maintaining reasonable performance
- **Maximum Performance Mode** (feature BFYB): Achieves maximum performance but with higher power consumption and lower energy efficiency.

For details about these preset modes, and all other performance and power efficiency UEFI settings offered in the SR635, see the paper "Tuning UEFI Settings for Performance and Energy Efficiency on AMD Processor-Based ThinkSystem Servers", available from <https://lenovopress.lenovo.com/lp1267>.

Memory options

The SR635 uses Lenovo TruDDR4 memory operating at up to 3200 MHz. The processors have 8 memory channels and support 2 DIMMs per channel, for a total of 16 DIMMs. The server supports up to 2TB of memory using 16x 128 GB 3DS RDIMMs.

The server supports these memory DIMMs:

- 2933 MHz DIMMs, that operate at 2933 MHz both at 1 DIMM per channel and 2 DIMMs per channel
- 3200 MHz DIMMs, that operate at 3200 MHz at 1 DIMM per channel, and at 2933 MHz at 2 DIMMs per channel

The following table lists the memory options that are available for the server.

Lenovo TruDDR4 memory uses the highest quality components that are sourced from Tier 1 DRAM suppliers and only memory that meets the strict requirements of Lenovo is selected. It is compatibility tested and tuned to maximize performance and reliability. From a service and support standpoint, Lenovo TruDDR4 memory automatically assumes the system warranty, and Lenovo provides service and support worldwide.

Table 16. Supported memory options

Part number	Feature code	Description	Maximum supported
2933 MHz memory			
4ZC7A08739	B7MS	ThinkSystem 8GB TruDDR4 2933MHz (1Rx8 1.2V) RDIMM-A	16
4ZC7A08740	B7MT	ThinkSystem 16GB TruDDR4 2933MHz (1Rx4 1.2V) RDIMM-A	16
4ZC7A08741	B7MU	ThinkSystem 16GB TruDDR4 2933MHz (2Rx8 1.2V) RDIMM-A	16
4ZC7A15113	B587	ThinkSystem 128GB TruDDR4 2933MHz (4Rx4 1.2V) 3DS RDIMM	16*
3200 MHz memory			
4ZC7A15121	B5XD	ThinkSystem 16GB TruDDR4 3200MHz (2Rx8 1.2V) RDIMM-A	16
4ZC7A15122	B5XE	ThinkSystem 32GB TruDDR4 3200MHz (2Rx4 1.2V) RDIMM-A	16
4ZC7A15123	B8NU	ThinkSystem 32GB TruDDR4 3200 MHz (2Rx8 1.2V) RDIMM-A	16
4ZC7A15124	B5XC	ThinkSystem 64GB TruDDR4 3200MHz (2Rx4 1.2V) RDIMM-A	16
4ZC7A15125	B8NT	ThinkSystem 128GB TruDDR4 3200MHz (4Rx4, 1.2V) 3DS RDIMM-A	16

* Supported in the SR635 only with an EPYC 7002 processor. Not supported with an EPYC 7003 processor.

The following rules apply when selecting the memory configuration:

- The 128GB 2933 MHz 3DS RDIMM, 4ZC7A15113, is only supported in the SR635 with an EPYC 7002 processor.
- The server supports RDIMMs and 3DS RDIMMs
- Mixing of RDIMMs and 3DS RDIMMs is not supported
- Mixing x4 and x8 DIMMs is supported, but not in the same channel
- Mixing of DIMM rank counts is supported. Follow the required installation order installing the DIMMs with the higher rank counts first.
- Mixing of DIMM capacities is supported, however only two different capacities are supported across all channels of the processor (eg 32GB and 64GB). Follow the required installation order installing the larger DIMMs first.
- Mixing of 3200 MHz and 2933 MHz DIMMs is supported. Installed memory will operate at the lower speed.
- Memory mirroring and memory rank sparing are not supported.
- When a GPU is added as a field upgrade, all empty DIMM slots must have a dummy DIMM blank installed in each DIMM slot, to ensure the optimal air flow. Ordering information is in the following table. For CTO orders, the dummy DIMMs are derived by the configurator.

Table 17. ThinkSystem Dummy DIMM Kit

Part number	Description	Quantity required
4M27A11810	ThinkSystem Dummy DIMM Package Kit (contains 24 dummy memory DIMMs)	1

For best performance, consider the following:

- Ensure the memory installed is at least the same speed as the memory bus of the selected processor.
- Populate memory DIMMs in quantities of 8 or 16, so that all memory channels are used.
- Populate memory channels so they all have the same total memory capacity.
- For more details on how to best configure the memory subsystem for performance, refer to the Lenovo Press paper “Balanced Memory Configurations with 2nd Gen and 3rd Gen AMD EPYC Processors” available from <https://lenovopress.com/lp1268-balanced-memory-configurations-with-amd-epyc-processors>

The following memory protection technologies are supported:

- ECC detection/correction
- SDDC (for x4-based memory DIMMs; look for "x4" in the DIMM description)
- Patrol/Demand Scrubbing
- DRAM Address Command Parity with Replay
- DRAM Uncorrected ECC Error Retry
- Post Package Repair

Internal storage

The SR635 supports 4x 3.5-inch or 16x 2.5-inch drive bays or a combination of drive bays, depending on the selected chassis and backplane configuration. The server also supports configurations without any drive bays if desired.

All drives are hot-swap and are accessible from the front, from the rear, or from drive bays that are located in the middle of the server (accessible when you remove the top cover of the server).

The three drive bay zones are as follows:

- Front: 4x 3.5-inch hot-swap bays or up to 10x 2.5-inch hot-swap bays
- Mid (internal): 4x 2.5-inch hot-swap bays
- Rear: up to 2x 2.5-inch hot-swap bays

The server also supports one or two M.2 drives, installed in an M.2 adapter.

In this section:

- [NVMe drive support](#)
- [Front drive bays](#)
- [Mid drive bays](#)
- [Rear drive bays](#)
- [Supported drive bay combinations](#)
- [Adapters selections](#)
- [Field upgrades](#)
- [M.2 drives](#)

NVMe drive support

PM983 hot-swap support: To support hot-swap of PM983 NVMe drives, the server needs to have UEFI v2.0 (Build ID CFE108O) or later installed.

The SR635 supports NVMe drives to maximize storage performance. The server supports up to 16 NVMe drives without oversubscription (that is, each x4 drive has a full x4 connection (4 lanes) to the processor):

- 10x NVMe drives in the front bays
- 4x NVMe drives in the mid bays
- 2x NVMe drives in the rear bays

The specifics of these configurations plus other NVMe-rich configurations are covered in the [Supported drive bay combinations](#) and [Adapters selections](#) sections.

The 10x NVMe drives at the front makes use of the 10-bay AnyBay backplane (feature B5VS) which requires SAS/SATA cabling and controllers as well as the NVMe cabling. However, if 16x NVMe drive bays are configured (ie all drive bays in the server populated with NVMe drives), then the server can be configured in the DCSC configurator without SAS/SATA cabling and controllers. Note that all 16x NVMe drive bays must be configured (using backplanes B5VS, B5VN and B5VQ); configurations of 10 or 12 or 14x NVMe drive bays will require SAS/SATA cabling and controllers.

15mm NVMe drives: 15mm NVMe SSDs are not supported in the mid or rear drive bays due to thermal requirements. Only 7mm NVMe drives are supported in those zones.

Front drive bays

The front drive bay zone supports the following configurations:

- 3.5-inch drive bays
 - No backplane and no drives (supports field upgrades)
 - 4x 3.5-inch SAS/SATA
- 2.5-inch drive bays
 - No backplane and no drives (supports field upgrades)
 - 8x 2.5-inch hot-swap SAS/SATA
 - 6x 2.5-inch hot-swap SAS/SATA + 4x 2.5-inch hot-swap AnyBay
 - 10x 2.5-inch hot-swap AnyBay

These configurations are shown in the following figure.

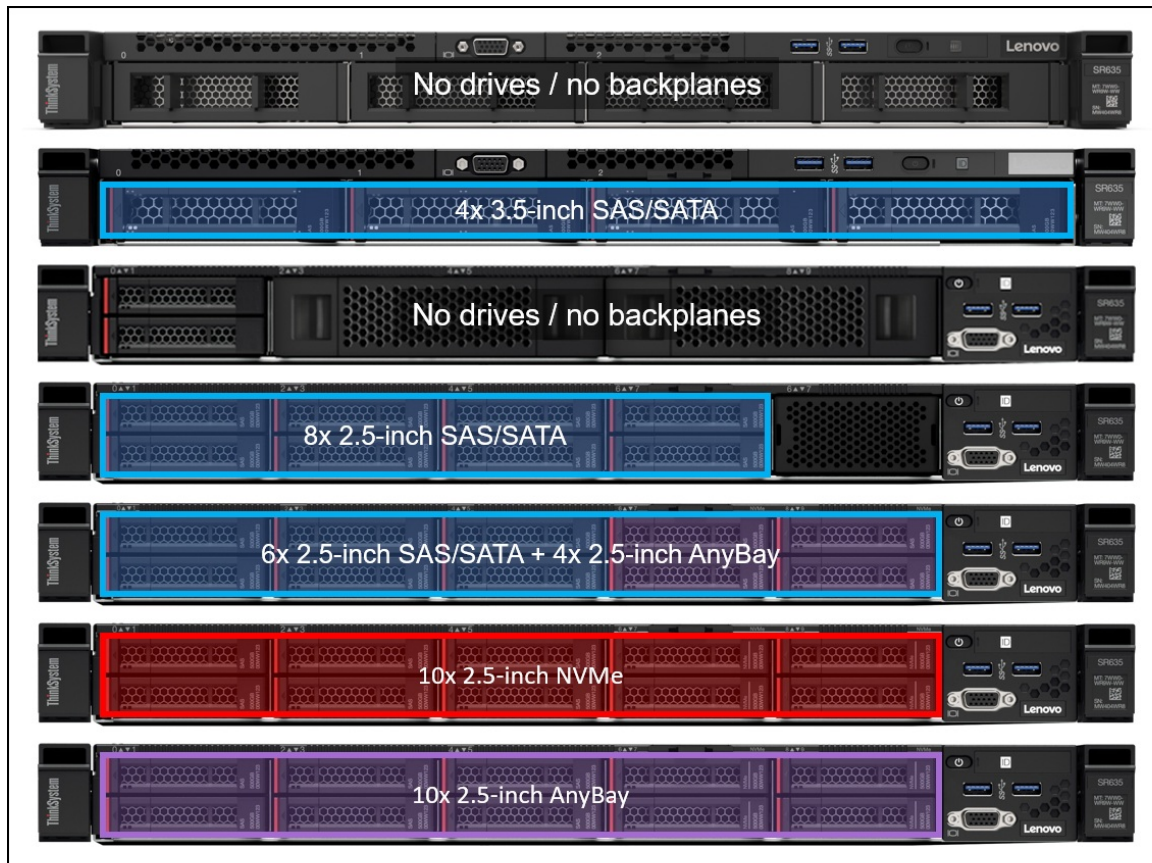

Figure 6. SR635 front drive bay configurations

The backplanes used to provide these drive bays are listed in the following table.

10x NVMe drive support: The server supports 10x 2.5-inch NVMe-only drive bays in the front of the server. Such support makes use of the 10-bay AnyBay backplane (feature B5VS), however the SAS/SATA connectors on the backplane are not connected, and no SAS/SATA cabling or controllers are configured.

Table 18. Backplanes for front drive bays

Part number	Feature code	Description	Maximum supported
Front 3.5-inch drive backplanes			
See note*	AUW8	ThinkSystem 1U 3.5" SATA/SAS 4-Bay Backplane (4x 3.5-inch SAS/SATA backplane)	1
Front 2.5-inch drive backplanes			
See note*	B7K3	ThinkSystem SR635 2.5" SATA/SAS 8-Bay Backplane (8x 2.5-inch SAS/SATA backplane)	1
See note*	AUW9	ThinkSystem 1U 10x2.5" (6x SAS/SATA 4x AnyBay) Backplane (10-bay 2.5-inch backplane with 6x SAS/SATA + 4x AnyBay bays†)	1
See note*	B5VS	ThinkSystem 1U 10x2.5" PCIe Gen4 AnyBay Backplane (10-bay 2.5-inch backplane with 10x AnyBay bays†)	1

* Backplanes are available as part numbers for field upgrades using upgrade kits, as described in the [Field upgrades](#) section below.

† AnyBay bays support SAS or SATA or NVMe drives; can also be configured as 10x NVMe drives without SAS/SATA cabling.

Mid drive bays

The SR635 optionally supports 4x 2.5-inch hot-swap NVMe drive bays installed in the middle of the server chassis. The drive bays are accessible by removing the top lid of the server and levering the mid drive chassis into an angled open position.

The drive bays, angled up, are shown in the following figure.

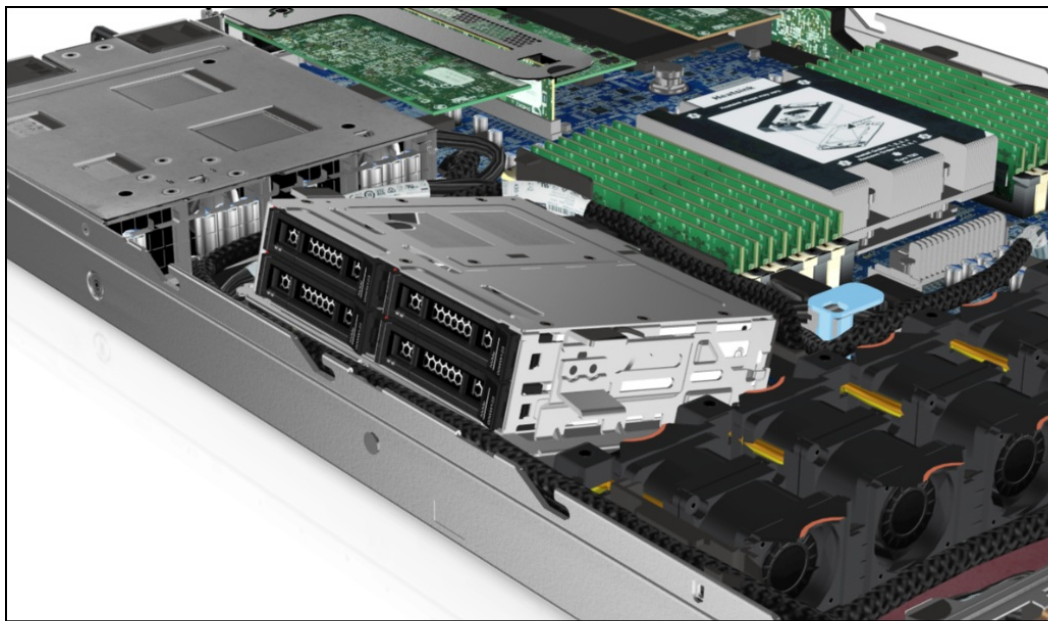

Figure 7. Mid-chassis drive bays (open position)

The backplanes used to provide these drive bays are listed in the following table.

Table 19. Backplanes for mid drive bays

Part number	Feature code	Description	Maximum supported
Mid - 2.5-inch drive backplanes			
See note*	B5VN	ThinkSystem 2.5" NVMe 4-Bay Middle Backplane (4x 2.5-inch NVMe backplane)	1

* Backplanes are available as part numbers for field upgrades using upgrade kits, as described in the [Field upgrades](#) section below.

The use of drive bays in the mid-chassis area has the following configuration rules:

- Only NVMe drives are supported in the mid chassis area. SAS and SATA drives are not supported.
- The mid drive cage is only supported in conjunction with the 10x 2.5-inch AnyBay backplane (feature AUW9) or the 4x 3.5-inch SAS/SATA backplane (feature AUW8) for the front drives. The use of other front-drive backplanes with the mid cage is not supported.
- The mid drive cage occupies the same physical space as the M.2 module, internal PCIe slot (slot 4) and two of the three holders for RAID power module (supercaps). As a result, the M.2 module, slot 4 and two supercaps cannot be installed.

Rear drive bays

The SR635 supports hot-swap drives installed at the rear of the server chassis. Supported configurations are as follows:

- 2x 2.5-inch hot-swap SAS/SATA drive bays
- 2x 2.5-inch hot-swap NVMe drive bays

The configurations are shown in the following figure.

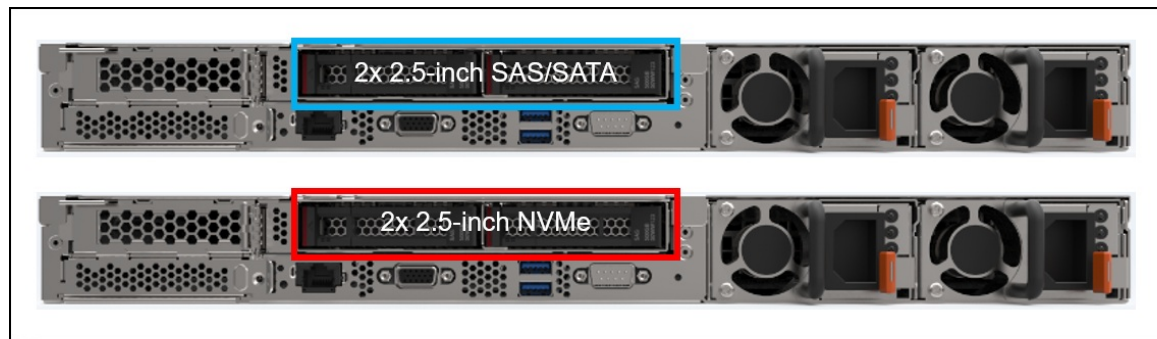

Figure 8. Rear drive bay configurations

The backplanes used to provide these drive bays are listed in the following table.

Table 20. Backplanes for rear drive bays

Part number	Feature code	Description	Maximum supported
Rear - 2.5-inch drive backplanes			
See note*	B5VR	ThinkSystem SR635 2.5" SATA/SAS 2-Bay Rear Backplane (2x 2.5-inch SAS/SATA backplane)	1
See note*	B5VQ	ThinkSystem 1U 2x2.5" NVMe Rear Backplane (2x 2.5-inch NVMe backplane)	1

* Backplanes are available as part numbers for field upgrades using upgrade kits, as described in the [Field upgrades](#) section below.

The use of rear drive bays has the following configuration rules:

- Slots 2 and 3 are not available
- Slot 1 is a low-profile slot
- GPUs are not supported

Supported drive bay combinations

This section describes the various combinations of 3.5-inch and 2.5-inch drives that the server supports. The drive bay combinations are grouped based on the drive type at the front of the server, 3.5-inch or 2.5-inch.

3.5-inch drive bay chassis

The following table shows the supported combinations when the server is configured with a 3.5-inch chassis (where the front drive bays are 3.5-inch). The choice of storage controller for each configuration is listed in the [Adapter selections](#) section.

Table 21. Drive bay combinations with 3.5-inch chassis (Blue cells = SAS/SATA, Red cells = NVMe)

Config	Total drives	Front bays (3.5")	Mid bays (2.5")	Rear bays (2.5")	
		SAS/SATA	NVMe	SAS/SATA	NVMe
A	4	4	0	0	0
B	6	4	0	2	0
C	6	4	0	0	2
D	8	4	4	0	0

2.5-inch drive bay chassis

The following table shows the supported combinations when the server is configured with a 2.5-inch chassis (where the front drive bays are 2.5-inch). The choice of storage controller for each configuration is listed in the [Adapter selections](#) section.

Table 22. Drive bay combinations with 2.5-inch chassis (Blue cells = SAS/SATA, Red cells = NVMe, Purple cells = AnyBay)

Config	Total drives	Front bays (2.5")			Mid bays (2.5")	Rear bays (2.5")	
		SAS/SATA	AnyBay	NVMe	NVMe	SAS/SATA	NVMe
2.5-inch chassis - only SAS/SATA drives in the front bays							
A	8	8	0	0	0	0	0
B	10	8	0	0	0	2	0
C	10	8	0	0	0	0	2
2.5-inch chassis - mix of SAS/SATA-only bays and AnyBay bays in the front							
D	10	6	4	0	0	0	0
E	12	6	4	0	0	2	0
F	12	6	4	0	0	0	2
2.5-inch chassis - all AnyBay bays in the front							
G	10	0	10	0	0	0	0
H	12	0	10	0	0	2	0
I	12	0	10	0	0	0	2
J	14	0	10	0	4	0	0
K	16	0	10	0	4	2	0
L	16	0	10	0	4	0	2
M	16	0	0	10	4	0	2

Adapter selections

The following tables lists the supported drive bay combinations plus the list of supported controller combinations supported by each of those drive bay combinations. Information about the controllers can be found in the [Controllers for internal storage](#) section.

Table 23. Drive bay combinations with 3.5-inch chassis (Blue cells = SAS/SATA, Red cells = NVMe)

Cfg	Total drives	Front bays (3.5")		Mid bays (2.5")		Rear bays (2.5")		Supported controller combinations (choose one) (OB = Onboard)
		SAS/SATA	NVMe	SAS/SATA	NVMe	SAS/SATA	NVMe	
A	4	4	0	0	0	0	0	<ul style="list-style-type: none"> • OB SATA • 530-8i • 730-8i 1G • 730-8i 2G • 930-8i • 430-8i
B	6	4	0	2	0	0	0	<ul style="list-style-type: none"> • OB SATA • 530-8i • 730-8i 1G • 730-8i 2G • 930-8i • 430-8i
C	6	4	0	0	0	2	0	<ul style="list-style-type: none"> • OB SATA + OB NVMe • 530-8i + OB NVMe • 730-8i 1G + OB NVMe • 730-8i 2G + OB NVMe • 930-8i + OB NVMe • 430-8i + OB NVMe
D	8	4	4	0	0	0	0	<ul style="list-style-type: none"> • OB SATA + OB NVMe (no M.2*) • 530-8i + OB NVMe (no M.2*) • 730-8i 1G + OB NVMe (no M.2*) • 430-8i + OB NVMe (no M.2*)

* The configurations with 4 mid drives do not support the M.2 Module because the mid drive bays and the M.2 Module occupy the same physical space.

Table 24. Drive bay combinations with 2.5-inch chassis (Blue cells = SAS/SATA, Red cells = NVMe, Purple cells = AnyBay)

Cfg	Total drives	Front bays (2.5")			Mid bays (2.5")	Rear bays (2.5")		Supported controller combinations (choose one) (OB = Onboard)
		SAS/SATA	AnyBay	NVMe	NVMe	SAS/SATA	NVMe	
2.5-inch chassis - only SAS/SATA drives in the front bays								
A	8	8	0	0	0	0	0	<ul style="list-style-type: none"> • OB SATA • 530-8i • 730-8i 1G • 730-8i 2G • 930-8i • 430-8i

Cfg	Total drives	Front bays (2.5")			Mid bays (2.5")	Rear bays (2.5")		Supported controller combinations (choose one) (OB = Onboard)
		SAS/SATA	AnyBay	NVMe	NVMe	SAS/SATA	NVMe	

B	10	8	0	0	0	2	0	<ul style="list-style-type: none"> • OB SATA • 2x 530-8i • 2x 730-8i 1G • 1x 530-8i + 1x 430-8i • 1x 930-16i • 2x 430-8i
C	10	8	0	0	0	0	2	<ul style="list-style-type: none"> • OB SATA + OB NVMe • 530-8i + OB NVMe • 730-8i 1G + OB NVMe • 730-8i 2G + OB NVMe • 930-8i + OB NVMe • 430-8i + OB NVMe

2.5-inch chassis - mix of SAS/SATA-only bays and AnyBay bays in the front

D	10	6	4	0	0	0	0	<ul style="list-style-type: none"> • OB SATA + OB NVMe • 1x 930-16i + OB NVMe • 1x 430-16i + OB NVMe
E	12	6	4	0	0	2	0	<ul style="list-style-type: none"> • OB SATA + OB NVMe (no M.2*) • 1x 930-16i + OB NVMe • 1x 430-16i + OB NVMe
F	12	6	4	0	0	0	2	<ul style="list-style-type: none"> • OB SATA + OB NVMe • 1x 930-16i + OB NVMe • 1x 430-16i + OB NVMe

2.5-inch chassis - all AnyBay bays in the front

G	10	0	10	0	0	0	0	<ul style="list-style-type: none"> • OB SATA + OB NVMe • 1x 930-16i + OB NVMe • 1x 430-16i + OB NVMe
H	12	0	10	0	0	2	0	<ul style="list-style-type: none"> • OB SATA + OB NVMe (no M.2*) • 1x 930-16i + OB NVMe • 1x 430-16i + OB NVMe
I	12	0	10	0	0	0	2	<ul style="list-style-type: none"> • 1x 930-16i + OB NVMe • 1x 430-16i + OB NVMe
J	14	0	10	0	4	0	0	<ul style="list-style-type: none"> • 1x 930-16i+OB NVMe (no M.2*) • 1x 430-16i+OB NVMe (no M.2*)

Cfg	Total drives	Front bays (2.5")			Mid bays (2.5")	Rear bays (2.5")		Supported controller combinations (choose one) (OB = Onboard)
		SAS/SATA	AnyBay	NVMe	NVMe	SAS/SATA	NVMe	
K	16	0	10	0	4	2	0	<ul style="list-style-type: none"> 1x 930-16i+OB NVMe (no M.2*) 1x 430-16i+OB NVMe (no M.2*)
L	16	0	10	0	4	0	2	<ul style="list-style-type: none"> 1x 930-16i+OB NVMe (no M.2*) 1x 430-16i+OB NVMe (no M.2*)
M	16	0	0	10	4	0	2	<ul style="list-style-type: none"> OB NVMe (no M.2*)

* These configurations, with 12 total SATA drives connected to the onboard SATA controller, or 4 mid drive bays, do not support the use of the M.2 Module. The M.2 Module and the onboard SATA bays use the same ports on the system board and the mid drive bays occupy the same space as the M.2 Module.

Field upgrades

This section describes the available upgrades to the storage subsystem.

- [Backplane kits](#)
- [Cable kits for 440 HBAs and RAID 940 adapters](#)
- [Cable kit for Onboard SATA controller upgrades \(X30 adapters only\)](#)
- [RAID flash power module \(supercap\)](#)

Backplane upgrades

The following table lists the option part numbers for the backplane kits that allow you to add additional drive bays as field upgrades. The table also lists what major components are included in each kit.

When adding drive bays, you will also need to add the appropriate storage controller(s). Consult the tables in the [Adapter selections](#) section to determine what controller sections are supported and what additional controllers you will need. Controllers are described in the [Controllers for internal storage](#) section.

Use with X40 adapters: These backplane kits in the table below include SAS/SATA cables for use with the onboard SATA controller or with RAID 930, 730, 530 adapters and 430 HBAs (collectively called X30 adapters). If you are adding or upgrading to RAID 940 adapters or 440 HBAs (collectively called X40 adapters), you will need to also order an X40 cable kit. See the [Cable kits for 440 HBAs and RAID 940 adapters](#) section for details.

Table 25. Drive backplane field upgrades

Part number	Description	Maximum supported
Front - 3.5-inch drive backplane (see Front drive bays)		
4XH7A09825	ThinkSystem SR635 3.5" SATA/SAS 4-Bay Backplane Kit <ul style="list-style-type: none"> • 1x 4-bay SAS/SATA backplane • SATA Cable Kits (power and SATA cables) • SAS/SATA Cable Kit (power cable, miniSAS-HD cable) 	1
Front - 2.5-inch drive backplanes (see Front drive bays)		

Part number	Description	Maximum supported
4XH7A09826	ThinkSystem SR635 2.5" SATA/SAS 8-Bay Backplane Kit <ul style="list-style-type: none"> • 1x 8-bay SAS/SATA backplane • 2-bay filler • SATA Cable Kits (power and SATA cables) • SAS/SATA Cable Kits (power cables, miniSAS-HD cables) 	1
4XH7A09827	ThinkSystem SR635 2.5" 4 Gen3 AnyBay 10-Bay BP Kit (10-bay 2.5-inch backplane with 6x SAS/SATA bays + 4x AnyBay bays†) <ul style="list-style-type: none"> • 1x 10-bay backplane (4 bays are AnyBay) • SATA Cable Kits (power and SATA cables) • SAS/SATA Cable Kits (power cables, miniSAS-HD cables) • NVMe cables (two slimline 1x8-to-2x4 cables) 	1
4XH7A09828	ThinkSystem SR635 2.5" 10 Gen4 AnyBay BP Kit (10-bay 2.5-inch backplane where all bays are AnyBay bays†) <ul style="list-style-type: none"> • 1x 10-bay backplane (all bays are AnyBay) • SATA Cable Kits (power and SATA cables) • SAS/SATA Cable Kits (power cables, miniSAS-HD cables) • NVMe cable kit 	1
Mid - 2.5-inch drive backplane (see Mid drive bays)		
4XH7A09856	ThinkSystem SR635 2.5" NVMe Gen4 4-Bay Middle Drive Kit <ul style="list-style-type: none"> • Mid-chassis 2.5-inch drive cage • 4-bay 2.5-inch NVMe backplane • 7x Performance fans (replaces existing fans) • Air baffle (replace existing baffle) • NVMe Cable Kit (power cable, signal cable) 	1
Rear - 2.5-inch drive backplanes (see Rear drive bays)		
4XH7A09852	ThinkSystem SR635 2.5" SATA/SAS 2-Bay Rear Drive Kit <ul style="list-style-type: none"> • Rear 2.5-inch drive cage • 2-bay 2.5-inch SAS/SATA rear backplane • 7x Performance fans (replaces existing fans) • SATA Cable Kit (power cable, SATA cable) • SAS/SATA Cable Kit (power cable, miniSAS-HD cable) 	1
4XH7A80466	ThinkSystem SR635 2.5" NVMe Gen4 2-Bay Rear Drive Kit v2 <ul style="list-style-type: none"> • Rear 2.5-inch drive cage • 2-bay 2.5-inch NVMe rear backplane • 7x Performance fans (replaces existing fans) • NVMe Cable Kit (power cable, signal cable) 	1
4XH7A09853	ThinkSystem SR635 2.5" NVMe Gen4 2-Bay Rear Drive Kit <ul style="list-style-type: none"> • Rear 2.5-inch drive cage • 2-bay 2.5-inch NVMe rear backplane • 7x Performance fans (replaces existing fans) • NVMe Cable Kit (power cable, signal cable) 	1

† AnyBay bays support SAS or SATA or NVMe drives

Cable kits for 440 HBAs and RAID 940 adapters

The backplane kits listed in the preceding table include cables for use with the onboard SATA controller or with RAID 930, 730, 530 adapters and 430 HBAs (collectively called X30 adapters). If you wish to use the backplane kits with RAID 940 adapters or 440 HBAs (collectively called X40 adapters), then you will also need to order an additional X40 cable kit to use instead of the cables in the backplane kit.

Unused cables: When adding an X40 adapter, you will order both the backplane kit and the relevant X40 cable kit, however the SAS/SATA data cable(s) in the backplane kit will not be used.

Upgrades from onboard SATA: If you are upgrading a system that currently uses the onboard SATA controller and has all necessary backplanes, simply order the relevant X40 cable kit as listed in the table.

Table 26. Cable kits for 440 HBAs and RAID 940 adapters

Backplane kits with X30 cables		X40 cable kits also needed	
Front - 3.5-inch drive backplane (see Front drive bays)			
4XH7A09825	ThinkSystem SR635 3.5" SATA/SAS 4-Bay Backplane Kit	4XH7A61120	ThinkSystem SR635 3.5" SAS/SATA 4-Bay X40 RAID Cable Kit
Front - 2.5-inch drive backplanes (see Front drive bays)			
4XH7A09826	ThinkSystem SR635 2.5" SATA/SAS 8-Bay Backplane Kit	4XH7A61121	ThinkSystem SR635 2.5" SAS/SATA 8-Bay X40 RAID Cable Kit
4XH7A09827	ThinkSystem SR635 2.5" 4 Gen3 AnyBay 10-Bay BP Kit	4XH7A61136	ThinkSystem SR635 Front 6x2.5" SAS/SATA + 4x2.5" AnyBay X40 RAID Cable Kit
4XH7A09828	ThinkSystem SR635 2.5" 10 Gen4 AnyBay BP Kit	4XH7A61127	ThinkSystem SR635 2.5" SAS/SATA/AnyBay 10-Bay X40 RAID Cable Kit
Mid - 2.5-inch drive backplane (see Mid drive bays)			
4XH7A09856	ThinkSystem SR635 2.5" NVMe Gen4 4-Bay Middle Drive Kit	None	Not supported – NVMe only
Rear - 2.5-inch drive backplanes (see Rear drive bays)			
4XH7A09852	ThinkSystem SR635 2.5" SATA/SAS 2-Bay Rear Drive Kit	4XH7A61128	ThinkSystem SR635 2.5" SAS/SATA 2-Bay Rear Backplane X40 RAID Cable Kit
4XH7A80466	ThinkSystem SR635 2.5" NVMe Gen4 2-Bay Rear Drive Kit v2	None	Not supported – NVMe only
4XH7A09853	ThinkSystem SR635 2.5" NVMe Gen4 2-Bay Rear Drive Kit	None	Not supported – NVMe only

Cable kit for Onboard SATA controller upgrades (X30 adapters only)

If your existing server is configured with drive backplanes that are connected to onboard SATA ports and you wish to upgrade to an X30 RAID adapter or SAS HBA (RAID 930, 730, 530 adapters and 430 HBAs), you will need to order the cable kit listed in the following table along with the adapter(s). The cable kit includes the additional cables you will need to connect the existing backplane to the new X30 adapter. Note that the kit includes the cables needed for all supported combinations of backplanes; this means that some of the cables in the kit will not be used.

For X40 RAID adapters and HBAs, instead order one of the X40 cable kits listed in the [Cable kits for 440 HBAs and RAID 940 adapters](#) section.

Table 27. RAID adapter cable kit for servers with backplanes (X30 adapters only)

Part number	Feature code	Description
4X97A59749	BCCC	ThinkSystem SR635 SAS Cable Kit, contains five cables: <ul style="list-style-type: none"> • 800mm MiniSAS-HD to MiniSAS-HD Cable C, SC17A50746 • 800mm Slimline4X to MiniSAS-HD Cable C, SC17A50732 • Front BP SAS/SATA Combo Cable A, SC17A59349 • 250mm HBA HD to HD Cable D, SC17A50750 • Front 1U 10 AnyBay BP SAS/SATA Combo Cable, SC17A59347

The cables in the kit are used with existing backplanes as listed in the following table.

Table 28. Use of SR635 SAS Cable Kit

Existing backplane	Needed cables
Front 3.5-inch 4x SATA/SATA Backplane	800mm MiniSAS-HD to MiniSAS-HD Cable C, SC17A50746
Front 2.5-inch 8x SAS/SATA Backplane	Front BP SAS/SATA Combo Cable A, SC17A59349
Front 2.5-inch 4x AnyBay+6x SAS/SATA Backplane	800mm MiniSAS-HD to MiniSAS-HD Cable C, SC17A50746
Front 2.5-inch 10x AnyBay Backplane	Front 1U 10 AnyBay BP SAS/SATA Combo Cable, SC17A59347 800mm Slimline4X to MiniSAS-HD Cable C, SC17A50732
Rear 2.5-inch 2x SAS/SATA Backplane	250mm HBA HD to HD Cable D, SC17A50750

RAID flash power module (supercap)

If you plan to add one of the RAID adapters that includes a RAID flash power module (supercap) as a field upgrade, then you will also need to order a Supercap installation kit for the power module. For CTO orders, the components in the installation kit are automatically derived when you select the RAID adapter. The adapters that this applies to are as follows:

- ThinkSystem RAID 730-8i 2GB Flash PCIe 12Gb Adapter
- ThinkSystem RAID 930-8i 2GB Flash PCIe 12Gb Adapter
- ThinkSystem RAID 930-16i 4GB Flash PCIe 12Gb Adapter
- ThinkSystem RAID 940-8i 4GB Flash PCIe Gen4 12Gb Adapter
- ThinkSystem RAID 940-16i 4GB Flash PCIe Gen4 12Gb Adapter

There are three possible locations for supercaps, as shown in the following figure.

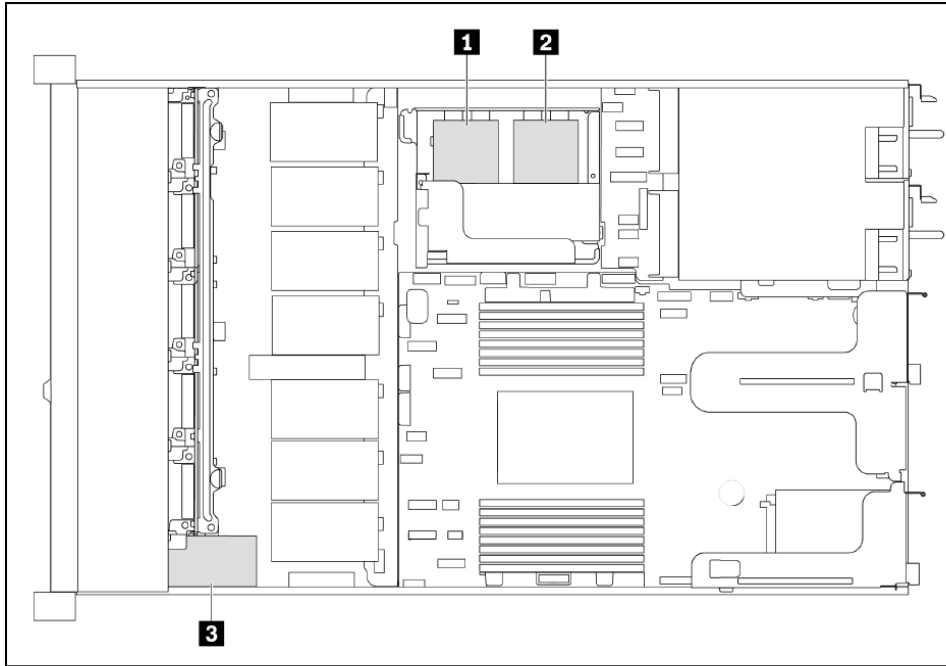

Figure 9. Location of all three supercaps in the SR635

The following configuration rules apply to the use of supercaps:

- Locations 1 and 2 are not available if the mid-chassis drive cage is installed
- Location 3 is only available with 2.5-inch front drive bays. It is not available if 3.5-inch front drives are used

When adding a RAID adapter and supercap as a field upgrade, order the supercap installation kit list listed in the following table.

Table 29. RAID Flash Power Module installation kit

Part number	Feature code	Description
4XH7A09847	B72A	ThinkSystem SR635/SR655 Supercap Installation Kit <ul style="list-style-type: none"> • 1x Bracket to hold two supercaps in their holders • 3x Supercap holders

The following figure shows the use of the components of the option kit to install 1 or 2 supercaps. The third supercap is installed in location 3 in front of the cooling fans and behind the front operator panel as shown in the preceding figure (2.5-inch chassis only; not available with 3.5-inch front drives).

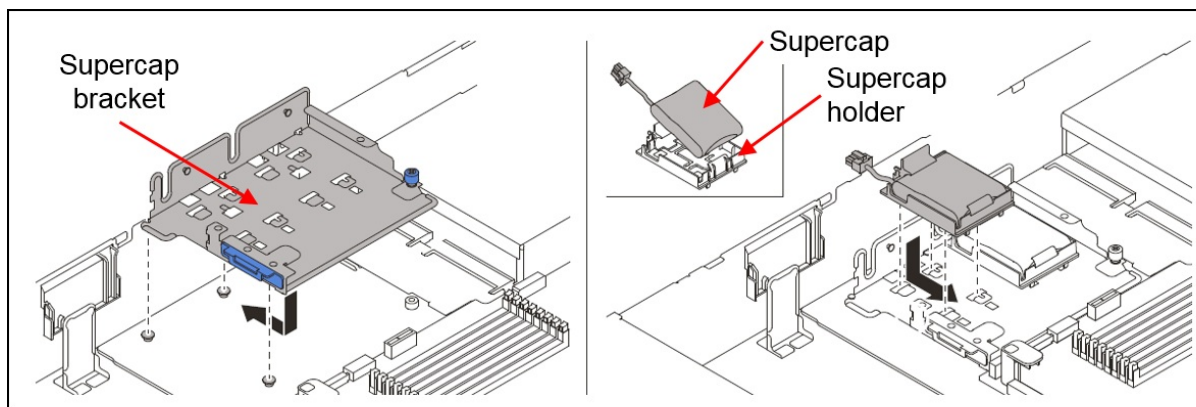

Figure 10. Supercap Installation Kit (locations 1 and 2)

M.2 drives

The server supports one or two M.2 form-factor SATA drives for use as an operating system boot solution or as additional storage. The M.2 drives install into an M.2 module which is mounted horizontally in the server adjacent to the internal storage controller slot as shown in the [Components and connectors](#) section.

M.2 restriction: The M.2 Module cannot be used in certain drive bay combinations:

- When 12 SATA or AnyBay drive bays are configured (10 front, 2 rear) and the SATA drives are connected to the onboard SATA controller (onboard SATA and M.2 use the same connector)
- When 4 mid-chassis drive bays are configured (M.2 occupies the same space)

See [Adapter selections](#) for the specific combinations where the M.2 Module is not supported.

There are two M.2 modules supported, as listed in the following table. The table also includes the cable kit needed for field upgrades.

Field upgrades: When ordering either option part number as a field upgrade, you will also need to order the M.2 Cable Kit which includes the necessary cables to connect the M.2 modules to the server. For CTO orders, the cable kit is not required; the cable and brackets are automatically included in the order.

Table 30. M.2 modules

Part number	Feature code	Description	Maximum supported
4Y37A09739	B5XH	ThinkSystem M.2 SATA 2-Bay RAID Enablement Kit	1
4Y37A09738	B5XJ	ThinkSystem M.2 SATA/NVMe 2-Bay Enablement Kit	1
4X97A59730	None	ThinkSystem SR635/SR655 M.2 Cable Kit (only needed for field upgrade to add 4Y37A09739 or 4Y37A09738) <ul style="list-style-type: none"> • Bracket to mount the M.2 module • Bracket for two supercap modules • M.2 signal/power cable 	1

Supported drives are listed in the [Internal drive options](#) section.

The SATA RAID Enablement Kit has the following features:

- Supports one or two SATA M.2 drives
- Support 42mm, 60mm and 80mm drive form factors (2242, 2260 and 2280)
- RAID support via an onboard Marvell 88SE9230 SATA RAID Controller
- Support JBOD, RAID-0 and RAID-1 (RAID support requires two M.2 drives)
- PCIe 2.0 x2 host interface; 6Gbps SATA connection to the drives
- Management and configuration support via UEFI and OS-based tools
- Supports monitoring and reporting of events and temperature through I2C
- Firmware update via Lenovo firmware update tools

The SATA/NVMe Enablement Kit has the following features:

- Supports one or two M.2 drives, either SATA or NVMe
- When two drives installed, they must be either both SATA or both NVMe
- Support 42mm, 60mm and 80mm drive form factors (2242, 2260 and 2280)
- JBOD support only; no RAID support
- Either 6Gbps SATA or PCIe 3.0 x1 interface to the drives depending on the drives installed
- Supports monitoring and reporting of events and temperature through I2C
- Firmware update via Lenovo firmware update tools

For further details about M.2 components, see the *ThinkSystem M.2 Drives and M.2 Adapters* product guide:

<https://lenovopress.com/lp0769-thinksystem-m2-drives-adapters>

Controllers for internal storage

The SR635 offers a variety of controller options for internal drives:

- Onboard SATA ports for up to 12 SATA drives
- RAID adapters and HBAs for SAS/SATA drives
- Onboard NVMe ports (for up to 16 NVMe drives)

The following table lists the adapters used for the internal storage of the server.

Table 31. Internal Storage adapter support

Part number	Feature code	Description	Power module (supercap)	Slots supported	Maximum supported
SAS/SATA RAID - PCIe 3.0					
7Y37A01082	AUNG	ThinkSystem RAID 530-8i PCIe 12Gb Adapter	No	4, 1, 3, 2	2
4Y37A78834	BMFT	ThinkSystem RAID 540-8i PCIe Gen4 12Gb Adapter	No	4, 1, 3, 2	2
7Y37A01083*	AUNH*	ThinkSystem RAID 730-8i 1GB Cache PCIe 12Gb Adapter	No	4, 1, 3, 2	2
4Y37A09722	B4RQ	ThinkSystem RAID 730-8i 2GB Flash PCIe 12Gb Adapter	Included	4, 1, 3, 2	1
7Y37A01084	AUNJ	ThinkSystem RAID 930-8i 2GB Flash PCIe 12Gb Adapter	Included	4, 1, 3, 2	1
7Y37A01085	AUNK	ThinkSystem RAID 930-16i 4GB Flash PCIe 12Gb Adapter	Included	4, 1, 3, 2	1
SAS/SATA RAID - PCIe 4.0 (No support for Tri-Mode)					
4Y37A09728	B8NY	ThinkSystem RAID 940-8i 4GB Flash PCIe Gen4 12Gb Adapter	Included	4, 1, 3, 2	1
4Y37A78600	BM35	ThinkSystem RAID 940-16i 4GB Flash PCIe Gen4 12Gb Adapter	Included	4, 1, 3, 2	1
SAS/SATA HBA - PCIe 3.0					
7Y37A01088	AUNL	ThinkSystem 430-8i SAS/SATA 12Gb HBA	No	1, 3, 2	2
7Y37A01089	AUNM	ThinkSystem 430-16i SAS/SATA 12Gb HBA	No	1, 3, 2	1
SAS/SATA HBA - PCIe 4.0					
4Y37A78601	BM51	ThinkSystem 440-8i SAS/SATA PCIe Gen4 12Gb HBA	No	4, 1, 3, 2	2
4Y37A78602	BM50	ThinkSystem 440-16i SAS/SATA PCIe Gen4 12Gb HBA	No	4, 1, 3, 2	1

* The RAID 730-8i 1GB Cache adapter is not available in USA and Canada.

For a comparison of the functions of the supported storage adapters, see the ThinkSystem RAID Adapter and HBA Reference:

<https://lenovopress.com/lp1288-thinksystem-raid-adapter-and-hba-reference#sr635-support=SR635>

For more information about the adapters see the product guides in the RAID adapters or HBA sections of the Lenovo Press web site:

<https://lenovopress.com/servers/options/raid>

<https://lenovopress.com/servers/options/hba>

Configuration notes:

- **Tri-Mode not supported:** In the SR635, the Tri-Mode (Trimode) feature of the RAID 940-8i and 940-16i adapters (support for NVMe U.3 drives) is not supported.
- **Field upgrades:** If you are adding a RAID adapter to the SR635 as a field upgrade, you will need a Supercap Installation Kit as described in the [Field upgrades](#) section. For use of 940 RAID adapters or 440 HBAs, you will also need a cable kit. Take note of the configuration rules in that section.
- **RAID 530-8i firmware:** If you plan to use the RAID 530-8i in the SR655, it must have firmware 50.3.0-1032 or later applied before it can be used in the server. If the adapter you plan to use has older firmware (for example, you are using an adapter you previously purchased), it must first be

upgrade by installing it in another server and upgrading the firmware there. For more information, see [Support tip HT509177](#).

Internal drive options

The following tables list the drive options for internal storage of the server.

2.5-inch hot-swap drives:

- [2.5-inch hot-swap 12 Gb SAS HDDs](#)
- [2.5-inch hot-swap 6 Gb SATA HDDs](#)
- [2.5-inch hot-swap 24 Gb SAS SSDs](#)
- [2.5-inch hot-swap 12 Gb SAS SSDs](#)
- [2.5-inch hot-swap 6 Gb SATA SSDs](#)
- [2.5-inch hot-swap PCIe 4.0 NVMe SSDs](#)
- [2.5-inch hot-swap PCIe 3.0 NVMe SSDs](#)

3.5-inch hot-swap drives:

- [3.5-inch hot-swap 12 Gb SAS HDDs](#)
- [3.5-inch hot-swap 6 Gb SATA HDDs](#)
- [3.5-inch hot-swap 24 Gb SAS SSDs](#)
- [3.5-inch hot-swap 12 Gb SAS SSDs](#)
- [3.5-inch hot-swap 6 Gb SATA SSDs](#)

M.2 drives:

- [M.2 SATA drives](#)

M.2 drive support: The use of M.2 drives requires an additional adapter as described in the [M.2 drives](#) subsection.

SED support: The tables include a column to indicate which drives support SED encryption. The encryption functionality can be disabled if needed. Note: Not all SED-enabled drives have "SED" in the description.

Table 32. 2.5-inch hot-swap 12 Gb SAS HDDs

Part number	Feature code	Description	SED support	Max Qty
2.5-inch hot-swap HDDs - 12 Gb SAS 15K				
7XB7A00021	AULV	ThinkSystem 2.5" 300GB 15K SAS 12Gb Hot Swap 512n HDD	No	12
7XB7A00022	AULW	ThinkSystem 2.5" 600GB 15K SAS 12Gb Hot Swap 512n HDD	No	12
7XB7A00023	AULX	ThinkSystem 2.5" 900GB 15K SAS 12Gb Hot Swap 512e HDD	No	12
2.5-inch hot-swap HDDs - 12 Gb SAS 10K				
7XB7A00024	AULY	ThinkSystem 2.5" 300GB 10K SAS 12Gb Hot Swap 512n HDD	No	12
7XB7A00025	AULZ	ThinkSystem 2.5" 600GB 10K SAS 12Gb Hot Swap 512n HDD	No	12
7XB7A00026	AUM0	ThinkSystem 2.5" 900GB 10K SAS 12Gb Hot Swap 512n HDD	No	12
7XB7A00027	AUM1	ThinkSystem 2.5" 1.2TB 10K SAS 12Gb Hot Swap 512n HDD	No	12
7XB7A00028	AUM2	ThinkSystem 2.5" 1.8TB 10K SAS 12Gb Hot Swap 512e HDD	No	12
2.5-inch hot-swap HDDs - 12 Gb NL SAS				
7XB7A00034	AUM6	ThinkSystem 2.5" 1TB 7.2K SAS 12Gb Hot Swap 512n HDD	No	12
7XB7A00035	AUM7	ThinkSystem 2.5" 2TB 7.2K SAS 12Gb Hot Swap 512n HDD	No	12
2.5-inch hot-swap SED HDDs - 12 Gb SAS 10K				
7XB7A00031	AUM5	ThinkSystem 2.5" 600GB 10K SAS 12Gb Hot Swap 512n HDD SED	Support	12

Table 33. 2.5-inch hot-swap 6 Gb SATA HDDs

Part number	Feature code	Description	SED support	Max Qty
2.5-inch hot-swap HDDs - 6 Gb NL SATA				
7XB7A00036	AUUE	ThinkSystem 2.5" 1TB 7.2K SATA 6Gb Hot Swap 512n HDD	No	12
7XB7A00037	AUJJ	ThinkSystem 2.5" 2TB 7.2K SATA 6Gb Hot Swap 512e HDD	No	12

Table 34. 2.5-inch hot-swap 24 Gb SAS SSDs

Part number	Feature code	Description	SED support	Max Qty
2.5-inch hot-swap SSDs - 24 Gb SAS - Mixed Use/Mainstream (3-5 DWPD)				
4XB7A80340	BNW8	ThinkSystem 2.5" PM1655 800GB Mixed Use SAS 24Gb HS SSD	Support	12
4XB7A80341	BNW9	ThinkSystem 2.5" PM1655 1.6TB Mixed Use SAS 24Gb HS SSD	Support	12
4XB7A80342	BNW6	ThinkSystem 2.5" PM1655 3.2TB Mixed Use SAS 24Gb HS SSD	Support	12
4XB7A80343	BP3K	ThinkSystem 2.5" PM1655 6.4TB Mixed Use SAS 24Gb HS SSD	Support	12
2.5-inch hot-swap SSDs - 24 Gb SAS - Read Intensive/Entry/Capacity (<3 DWPD)				
4XB7A80318	BNWC	ThinkSystem 2.5" PM1653 960GB Read Intensive SAS 24Gb HS SSD	Support	12
4XB7A80319	BNWE	ThinkSystem 2.5" PM1653 1.92TB Read Intensive SAS 24Gb HS SSD	Support	12
4XB7A80320	BNWF	ThinkSystem 2.5" PM1653 3.84TB Read Intensive SAS 24Gb HS SSD	Support	12
4XB7A80321	BP3E	ThinkSystem 2.5" PM1653 7.68TB Read Intensive SAS 24Gb HS SSD	Support	12
4XB7A80322	BP3J	ThinkSystem 2.5" PM1653 15.36TB Read Intensive SAS 24Gb HS SSD	Support	12
4XB7A80323	BP3D	ThinkSystem 2.5" PM1653 30.72TB Read Intensive SAS 24Gb HS SSD	Support	12

Table 35. 2.5-inch hot-swap 12 Gb SAS SSDs

Part number	Feature code	Description	SED support	Max Qty
2.5-inch hot-swap SSDs - 12 Gb SAS - Write Intensive/Performance (10+ DWPD)				
4XB7A83214	BR10	ThinkSystem 2.5" Nytro 3750 400GB Write Intensive SAS 12Gb HS SSD	Support	12
4XB7A83215	BR0Z	ThinkSystem 2.5" Nytro 3750 800GB Write Intensive SAS 12Gb HS SSD	Support	12
4XB7A83216	BR0Y	ThinkSystem 2.5" Nytro 3750 1.6TB Write Intensive SAS 12Gb HS SSD	Support	12
4XB7A83217	BR0X	ThinkSystem 2.5" Nytro 3750 3.2TB Write Intensive SAS 12Gb HS SSD	Support	12
4XB7A70003	BG04	ThinkSystem 2.5" Nytro 3732 3.2TB Performance SAS 12Gb Hot Swap SSD	No	12
2.5-inch hot-swap SSDs - 12 Gb SAS - Mixed Use/Mainstream (3-5 DWPD)				
4XB7A17062	B8HU	ThinkSystem 2.5" PM1645a 800GB Mainstream SAS 12Gb Hot Swap SSD	No	12
2.5-inch hot-swap SSDs - 12 Gb SAS - Read Intensive/Entry/Capacity (<3 DWPD)				
4XB7A38175	B91A	ThinkSystem 2.5" PM1643a 960GB Entry SAS 12Gb Hot Swap SSD	No	12

Table 36. 2.5-inch hot-swap 6 Gb SATA SSDs

Part number	Feature code	Description	SED support	Max Qty
2.5-inch hot-swap SSDs - 6 Gb SATA - Mixed Use/Mainstream (3-5 DWPD)				
4XB7A82289	BQ21	ThinkSystem 2.5" 5400 MAX 480GB Mixed Use SATA 6Gb HS SSD	Support	12
4XB7A82290	BQ24	ThinkSystem 2.5" 5400 MAX 960GB Mixed Use SATA 6Gb HS SSD	Support	12
4XB7A82291	BQ22	ThinkSystem 2.5" 5400 MAX 1.92TB Mixed Use SATA 6Gb HS SSD	Support	12
4XB7A82292	BQ23	ThinkSystem 2.5" 5400 MAX 3.84TB Mixed Use SATA 6Gb HS SSD	Support	12
4XB7A17125	BA7Q	ThinkSystem 2.5" S4620 480GB Mixed Use SATA 6Gb HS SSD	No	12
4XB7A17126	BA4T	ThinkSystem 2.5" S4620 960GB Mixed Use SATA 6Gb HS SSD	No	12
4XB7A17127	BA4U	ThinkSystem 2.5" S4620 1.92TB Mixed Use SATA 6Gb HS SSD	No	12
4XB7A17128	BK7L	ThinkSystem 2.5" S4620 3.84TB Mixed Use SATA 6Gb HS SSD	No	12
4XB7A17089	B8J6	ThinkSystem 2.5" 5300 960GB Mainstream SATA 6Gb Hot Swap SSD	No	12
4XB7A17090	B8JE	ThinkSystem 2.5" 5300 1.92TB Mainstream SATA 6Gb Hot Swap SSD	No	12
4XB7A17091	B8J7	ThinkSystem 2.5" 5300 3.84TB Mainstream SATA 6Gb Hot Swap SSD	No	12
4XB7A13637	B49Q	ThinkSystem 2.5" S4610 3.84TB Mixed Use SATA 6Gb HS SSD	No	12
2.5-inch hot-swap SSDs - 6 Gb SATA - Read Intensive/Entry (<3 DWPD)				
4XB7A82258	BQ1Q	ThinkSystem 2.5" 5400 PRO 240GB Read Intensive SATA 6Gb HS SSD	Support	12
4XB7A82259	BQ1P	ThinkSystem 2.5" 5400 PRO 480GB Read Intensive SATA 6Gb HS SSD	Support	12
4XB7A82260	BQ1R	ThinkSystem 2.5" 5400 PRO 960GB Read Intensive SATA 6Gb HS SSD	Support	12
4XB7A82261	BQ1X	ThinkSystem 2.5" 5400 PRO 1.92TB Read Intensive SATA 6Gb HS SSD	Support	12
4XB7A82262	BQ1S	ThinkSystem 2.5" 5400 PRO 3.84TB Read Intensive SATA 6Gb HS SSD	Support	12
4XB7A82263	BQ1T	ThinkSystem 2.5" 5400 PRO 7.68TB Read Intensive SATA 6Gb HS SSD	Support	12
4XB7A72438	BM8B	ThinkSystem 2.5" PM893 480GB Read Intensive SATA 6Gb HS SSD	No	12
4XB7A72439	BM8A	ThinkSystem 2.5" PM893 960GB Read Intensive SATA 6Gb HS SSD	No	12
4XB7A72440	BM89	ThinkSystem 2.5" PM893 1.92TB Read Intensive SATA 6Gb HS SSD	No	12
4XB7A72441	BM88	ThinkSystem 2.5" PM893 3.84TB Read Intensive SATA 6Gb HS SSD	No	12
4XB7A72442	BM87	ThinkSystem 2.5" PM893 7.68TB Read Intensive SATA 6Gb HS SSD	No	12
4XB7A17072	B99D	ThinkSystem 2.5" S4520 240GB Read Intensive SATA 6Gb HS SSD	No	12
4XB7A17101	BA7G	ThinkSystem 2.5" S4520 480GB Read Intensive SATA 6Gb HS SSD	No	12
4XB7A17102	BA7H	ThinkSystem 2.5" S4520 960GB Read Intensive SATA 6Gb HS SSD	No	12
4XB7A17103	BA7J	ThinkSystem 2.5" S4520 1.92TB Read Intensive SATA 6Gb HS SSD	No	12
4XB7A17104	BK77	ThinkSystem 2.5" S4520 3.84TB Read Intensive SATA 6Gb HS SSD	No	12
4XB7A17105	BK78	ThinkSystem 2.5" S4520 7.68TB Read Intensive SATA 6Gb HS SSD	No	12
4XB7A38271	BCTC	ThinkSystem 2.5" Multi Vendor 240GB Entry SATA 6Gb Hot Swap SSD	No	12
4XB7A38273	BCTE	ThinkSystem 2.5" Multi Vendor 960GB Entry SATA 6Gb Hot Swap SSD	No	12
4XB7A38274	BCTF	ThinkSystem 2.5" Multi Vendor 1.92TB Entry SATA 6Gb Hot Swap SSD	No	12

Part number	Feature code	Description	SED support	Max Qty
4XB7A38275	BCTG	ThinkSystem 2.5" Multi Vendor 3.84TB Entry SATA 6Gb Hot Swap SSD	No	12
4XB7A17075	B8HV	ThinkSystem 2.5" 5300 240GB Entry SATA 6Gb Hot Swap SSD	No	12
4XB7A38141	BE29	ThinkSystem 2.5" 5300 960GB Entry SATA 6Gb Hot Swap SSD SED	Support	12
4XB7A17080	B8J2	ThinkSystem 2.5" 5300 7.68TB Entry SATA 6Gb Hot Swap SSD	No	12
4XB7A38185	B9AC	ThinkSystem 2.5" 5210 960GB Entry SATA 6Gb Hot Swap QLC SSD	No	12
4XB7A38144	B7EW	ThinkSystem 2.5" 5210 1.92TB Entry SATA 6Gb Hot Swap QLC SSD	No	12
4XB7A38145	B7EX	ThinkSystem 2.5" 5210 3.84TB Entry SATA 6Gb Hot Swap QLC SSD	No	12
4XB7A38146	B7EY	ThinkSystem 2.5" 5210 7.68TB Entry SATA 6Gb Hot Swap QLC SSD	No	12

Table 37. 2.5-inch hot-swap PCIe 4.0 NVMe SSDs

Part number	Feature code	Description	SED support	Max Qty
2.5-inch SSDs - U.2 PCIe 4.0 NVMe - Mixed Use/Mainstream (3-5 DWPD)				
4XB7A17129	BNEG	ThinkSystem 2.5" U.2 P5620 1.6TB Mixed Use NVMe PCIe 4.0 x4 HS SSD	Support	10*
4XB7A17130	BNEH	ThinkSystem 2.5" U.2 P5620 3.2TB Mixed Use NVMe PCIe 4.0 x4 HS SSD	Support	10*
4XB7A17133	BNEZ	ThinkSystem 2.5" U.2 P5620 6.4TB Mixed Use NVMe PCIe 4.0 x4 HS SSD	Support	10*
4XB7A17136	BA4V	ThinkSystem 2.5" U.2 P5620 12.8TB Mixed Use NVMe PCIe 4.0 x4 HS SSD	Support	10*
2.5-inch SSDs - U.3 PCIe 4.0 NVMe - Mixed Use/Mainstream (3-5 DWPD)				
4XB7A79639	BNF1	ThinkSystem 2.5" U.3 7450 MAX 800GB Mixed Use NVMe PCIe 4.0 x4 HS SSD	Support	10*
4XB7A13967	BNEJ	ThinkSystem 2.5" U.3 7450 MAX 1.6TB Mixed Use NVMe PCIe 4.0 x4 HS SSD	Support	10*
4XB7A13970	BNEY	ThinkSystem 2.5" U.3 7450 MAX 3.2TB Mixed Use NVMe PCIe 4.0 x4 HS SSD	Support	10*
4XB7A13971	BNEL	ThinkSystem 2.5" U.3 7450 MAX 6.4TB Mixed Use NVMe PCIe 4.0 x4 HS SSD	Support	10*
4XB7A84056	BRG0	ThinkSystem 2.5" U.3 7450 MAX 12.8TB Mixed Use NVMe PCIe 4.0 x4 HS SSD	Support	10*
4XB7A64175	BE03	ThinkSystem U.3 Kioxia CM6-V 800GB Mainstream NVMe PCIe 4.0 x4 Hot Swap SSD	No	10*
4XB7A17112	B96Z	ThinkSystem U.3 Kioxia CM6-V 1.6TB Mainstream NVMe PCIe4.0 x4 Hot Swap SSD	No	10*
4XB7A17113	B96T	ThinkSystem U.3 Kioxia CM6-V 3.2TB Mainstream NVMe PCIe4.0 x4 Hot Swap SSD	No	10*
4XB7A17114	B96P	ThinkSystem U.3 Kioxia CM6-V 6.4TB Mainstream NVMe PCIe4.0 x4 Hot Swap SSD	No	10*
2.5-inch SSDs - U.2 PCIe 4.0 NVMe - Read Intensive/Entry (<3 DWPD)				
4XB7A13941	BMGD	ThinkSystem 2.5" U.2 P5520 1.92TB Read Intensive NVMe PCIe 4.0 x4 HS SSD	Support	10*

Part number	Feature code	Description	SED support	Max Qty
4XB7A13942	BMGE	ThinkSystem 2.5" U.2 P5520 3.84TB Read Intensive NVMe PCIe 4.0 x4 HS SSD	Support	10*
4XB7A13943	BNEF	ThinkSystem 2.5" U.2 P5520 7.68TB Read Intensive NVMe PCIe 4.0 x4 HS SSD	Support	10*
4XB7A13631	BNEQ	ThinkSystem 2.5" U.2 P5520 15.36TB Read Intensive NVMe PCIe 4.0 x4 HS SSD	Support	10*
4XB7A17145	BCFT	ThinkSystem 2.5" U.2 P5500 1.92TB Read Intensive NVMe PCIe 4.0 x4 HS SSD	No	10*
4XB7A17147	BCFU	ThinkSystem 2.5" U.2 P5500 7.68TB Read Intensive NVMe PCIe 4.0 x4 HS SSD	No	10*
4XB7A38196	BC4Y	ThinkSystem U.2 PM1733 1.92TB Entry NVMe PCIe 4.0 x4 Hot Swap SSD	No	10*
4XB7A38197	BC4Z	ThinkSystem U.2 PM1733 3.84TB Entry NVMe PCIe 4.0 x4 Hot Swap SSD	No	10*
4XB7A38283	BE2E	ThinkSystem U.2 PM1733 7.68TB Entry NVMe PCIe 4.0 x4 Hot Swap SSD	No	10*
4XB7A38284	BE2F	ThinkSystem U.2 PM1733 15.36TB Entry NVMe PCIe 4.0 x4 Hot Swap SSD	No	10*
2.5-inch SSDs - U.3 PCIe 4.0 NVMe - Read Intensive/Entry (<3 DWPD)				
4XB7A81951	BPKX	ThinkSystem 2.5" U.3 PM1733a 1.92TB Read Intensive NVMe PCIe 4.0 x4 HS SSD	Support	10*
4XB7A81952	BPKY	ThinkSystem 2.5" U.3 PM1733a 3.84TB Read Intensive NVMe PCIe 4.0 x4 HS SSD	Support	10*
4XB7A81953	BPKZ	ThinkSystem 2.5" U.3 PM1733a 7.68TB Read Intensive NVMe PCIe 4.0 x4 HS SSD	Support	10*
4XB7A81954	BPL0	ThinkSystem 2.5" U.3 PM1733a 15.36TB Read Intensive NVMe PCIe 4.0 x4 HS SSD	Support	10*
4XB7A81999	BPL1	ThinkSystem 2.5" U.3 PM1733a 30.72TB Read Intensive NVMe PCIe 4.0 x4 HS SSD	Support	10*
4XB7A79646	BNF3	ThinkSystem 2.5" U.3 7450 PRO 960GB Read Intensive NVMe PCIe 4.0 x4 HS SSD	Support	10*
4XB7A79647	BNF2	ThinkSystem 2.5" U.3 7450 PRO 1.92TB Read Intensive NVMe PCIe 4.0 x4 HS SSD	Support	10*
4XB7A79648	BNF5	ThinkSystem 2.5" U.3 7450 PRO 3.84TB Read Intensive NVMe PCIe 4.0 x4 HS SSD	Support	10*
4XB7A79649	BNF4	ThinkSystem 2.5" U.3 7450 PRO 7.68TB Read Intensive NVMe PCIe 4.0 x4 HS SSD	Support	10*
4XB7A83097	BQAV	ThinkSystem 2.5" U.3 7450 PRO 15.36TB Read Intensive NVMe PCIe 4.0 x4 HS SSD	Support	10*

* All NVMe drives, with the exception of PM983 drives, are only supported in the front drive bays due to thermal requirements

Note: NVMe PCIe SSDs support surprise hot removal and hot insertion, provided the operating system supports PCIe SSD hot-swap.

Table 38. 2.5-inch hot-swap PCIe 3.0 NVMe SSDs

Part number	Feature code	Description	SED support	Max Qty
2.5-inch SSDs - U.2 PCIe 3.0 NVMe - Read Intensive/Entry (<3 DWPD)				
4XB7A10205	B58H	ThinkSystem U.2 Intel P4510 4.0TB Entry NVMe PCIe3.0 x4 Hot Swap SSD	No	10*
4XB7A10175	B34N	ThinkSystem U.2 PM983 1.92TB Entry NVMe PCIe 3.0 x4 Hot Swap SSD	No	16
4XB7A10176	B34P	ThinkSystem U.2 PM983 3.84TB Entry NVMe PCIe 3.0 x4 Hot Swap SSD	No	16

* All NVMe drives, with the exception of PM983 drives, are only supported in the front drive bays due to thermal requirements

Note: NVMe PCIe SSDs support surprise hot removal and hot insertion, provided the operating system supports PCIe SSD hot-swap.

Table 39. 3.5-inch hot-swap 12 Gb SAS HDDs

Part number	Feature code	Description	SED support	Max Qty
3.5-inch hot-swap HDDs - 12 Gb SAS 10K				
7XB7A00063	B1JJ	ThinkSystem 3.5" 300GB 10K SAS 12Gb Hot Swap 512n HDD	No	4
3.5-inch hot-swap HDDs - 12 Gb SAS 15K				
7XB7A00039	AUU3	ThinkSystem 3.5" 600GB 15K SAS 12Gb Hot Swap 512n HDD	No	4
7XB7A00040	AUUC	ThinkSystem 3.5" 900GB 15K SAS 12Gb Hot Swap 512e HDD	No	4
3.5-inch hot-swap HDDs - 12 Gb NL SAS				
7XB7A00042	AUU5	ThinkSystem 3.5" 2TB 7.2K SAS 12Gb Hot Swap 512n HDD	No	4
7XB7A00043	AUU6	ThinkSystem 3.5" 4TB 7.2K SAS 12Gb Hot Swap 512n HDD	No	4
7XB7A00044	AUU7	ThinkSystem 3.5" 6TB 7.2K SAS 12Gb Hot Swap 512e HDD	No	4
4XB7A17222	BCM2	ThinkSystem SR635 3.5" 8TB 7.2K SAS 12Gb Hot Swap 512e HDD	No	4
7XB7A00046	AUUG	ThinkSystem 3.5" 10TB 7.2K SAS 12Gb Hot Swap 512e HDD	No	4
4XB7A17223	BCM6	ThinkSystem SR635/SR655 3.5" 12TB 7.2K SAS 12Gb Hot Swap 512e HDD	No	4
4XB7A17224	BCM4	ThinkSystem SR635/SR655 3.5" 14TB 7.2K SAS 12Gb Hot Swap 512e HDD	No	4
4XB7A13911	B7EZ	ThinkSystem 3.5" 16TB 7.2K SAS 12Gb Hot Swap 512e HDD	No	4
4XB7A76340	BHX6	ThinkSystem SR635/SR645/SR655 3.5" 18TB 7.2K SAS 12Gb Hot Swap 512e HDD	No	4
4XB7A80353	BPKU	ThinkSystem 3.5" 20TB 7.2K SAS 12Gb Hot Swap 512e HDD	No	4
4XB7A83766	BTR7	ThinkSystem 3.5" 22TB 7.2K SAS 12Gb Hot Swap 512e HDD	No	4
3.5-inch hot-swap SED HDDs - 12 Gb NL SAS				
7XB7A00047	AUUH	ThinkSystem 3.5" 4TB 7.2K SAS 12Gb Hot Swap 512n HDD FIPS	Support	4
7XB7A00048	B0YP	ThinkSystem 3.5" 6TB 7.2K SAS 12Gb Hot Swap 512e HDD FIPS	Support	4

Table 40. 3.5-inch hot-swap 6 Gb SATA HDDs

Part number	Feature code	Description	SED support	Max Qty
3.5-inch hot-swap HDDs - 6 Gb NL SATA				
7XB7A00050	AUUD	ThinkSystem 3.5" 2TB 7.2K SATA 6Gb Hot Swap 512n HDD	No	4
7XB7A00051	AUU8	ThinkSystem 3.5" 4TB 7.2K SATA 6Gb Hot Swap 512n HDD	No	4
7XB7A00052	AUUA	ThinkSystem 3.5" 6TB 7.2K SATA 6Gb Hot Swap 512e HDD	No	4
4XB7A17225	BCM7	ThinkSystem SR635 3.5" 8TB 7.2K SATA 12Gb Hot Swap 512e HDD	No	4
7XB7A00054	AUUB	ThinkSystem 3.5" 10TB 7.2K SATA 6Gb Hot Swap 512e HDD	No	4
4XB7A17226	BCM5	ThinkSystem SR635/SR655 3.5" 12TB 7.2K SATA 6Gb Hot Swap 512e HDD	No	4
4XB7A38184	BCM3	ThinkSystem SR635/SR655 3.5" 14TB 7.2K SATA 6Gb Hot Swap 512e HDD	No	4
4XB7A13914	B7F0	ThinkSystem 3.5" 16TB 7.2K SATA 6Gb Hot Swap 512e HDD	No	4
4XB7A76341	BHX5	ThinkSystem SR635/SR645/SR655 3.5" 18TB 7.2K SATA 6Gb Hot Swap 512e HDD	No	4
4XB7A80354	BPKV	ThinkSystem 3.5" 20TB 7.2K SATA 6Gb Hot Swap 512e HDD	No	4
4XB7A83765	BTR8	ThinkSystem 3.5" 22TB 7.2K SATA 6Gb Hot Swap 512e HDD	No	4

Table 41. 3.5-inch hot-swap 24 Gb SAS SSDs

Part number	Feature code	Description	SED support	Max Qty
3.5-inch hot-swap SSDs - 24 Gb SAS - Mixed Use/Mainstream (3-5 DWPD)				
4XB7A80344	BNW7	ThinkSystem 3.5" PM1655 800GB Mixed Use SAS 24Gb HS SSD	Support	4
4XB7A80345	BNWA	ThinkSystem 3.5" PM1655 1.6TB Mixed Use SAS 24Gb HS SSD	Support	4
4XB7A80346	BNWB	ThinkSystem 3.5" PM1655 3.2TB Mixed Use SAS 24Gb HS SSD	Support	4
4XB7A80347	BP3G	ThinkSystem 3.5" PM1655 6.4TB Mixed Use SAS 24Gb HS SSD	Support	4
3.5-inch hot-swap SSDs - 24 Gb SAS - Read Intensive/Entry/Capacity (<3 DWPD)				
4XB7A80324	BNWD	ThinkSystem 3.5" PM1653 960GB Read Intensive SAS 24Gb HS SSD	Support	4
4XB7A80325	BNWG	ThinkSystem 3.5" PM1653 1.92TB Read Intensive SAS 24Gb HS SSD	Support	4
4XB7A80326	BNWH	ThinkSystem 3.5" PM1653 3.84TB Read Intensive SAS 24Gb HS SSD	Support	4
4XB7A80327	BP3F	ThinkSystem 3.5" PM1653 7.68TB Read Intensive SAS 24Gb HS SSD	Support	4
4XB7A80328	BP3H	ThinkSystem 3.5" PM1653 15.36TB Read Intensive SAS 24Gb HS SSD	Support	4

Table 42. 3.5-inch hot-swap 12 Gb SAS SSDs

Part number	Feature code	Description	SED support	Max Qty
3.5-inch hot-swap SSDs - 12 Gb SAS - Write Intensive/Performance (10+ DWPD)				
4XB7A83218	BR0W	ThinkSystem 3.5" Nytro 3750 400GB Write Intensive SAS 12Gb HS SSD	Support	4
4XB7A83219	BR0V	ThinkSystem 3.5" Nytro 3750 800GB Write Intensive SAS 12Gb HS SSD	Support	4
4XB7A83220	BR0U	ThinkSystem 3.5" Nytro 3750 1.6TB Write Intensive SAS 12Gb HS SSD	Support	4
4XB7A83221	BR0T	ThinkSystem 3.5" Nytro 3750 3.2TB Write Intensive SAS 12Gb HS SSD	Support	4
4XB7A70008	BG00	ThinkSystem 3.5" Nytro 3732 3.2TB Performance SAS 12Gb Hot Swap SSD	No	4
3.5-inch hot-swap SSDs - 12 Gb SAS - Mixed Use/Mainstream (3-5 DWPD)				
4XB7A17066	B8HT	ThinkSystem 3.5" PM1645a 800GB Mainstream SAS 12Gb Hot Swap SSD	No	4

Table 43. 3.5-inch hot-swap 6 Gb SATA SSDs

Part number	Feature code	Description	SED support	Max Qty
3.5-inch hot-swap SSDs - 6 Gb SATA - Mixed Use/Mainstream (3-5 DWPD)				
4XB7A87202	BURK	ThinkSystem 3.5" 5400 MAX 1.92TB Mixed Use SATA 6Gb HS SSD	Support	4
4XB7A17137	BA4W	ThinkSystem 3.5" S4620 480GB Mixed Use SATA 6Gb HS SSD	No	4
4XB7A17138	BA4X	ThinkSystem 3.5" S4620 960GB Mixed Use SATA 6Gb HS SSD	No	4
4XB7A17139	BA4Y	ThinkSystem 3.5" S4620 1.92TB Mixed Use SATA 6Gb HS SSD	No	4
4XB7A17140	BK7P	ThinkSystem 3.5" S4620 3.84TB Mixed Use SATA 6Gb HS SSD	No	4
4XB7A17098	B8J0	ThinkSystem 3.5" 5300 960GB Mainstream SATA 6Gb Hot Swap SSD	No	4
4XB7A17099	B8HR	ThinkSystem 3.5" 5300 1.92TB Mainstream SATA 6Gb Hot Swap SSD	No	4
4XB7A17100	B8HX	ThinkSystem 3.5" 5300 3.84TB Mainstream SATA 6Gb Hot Swap SSD	No	4
3.5-inch hot-swap SSDs - 6 Gb SATA - Read Intensive/Entry (<3 DWPD)				
4XB7A17118	BA7K	ThinkSystem 3.5" S4520 240GB Read Intensive SATA 6Gb HS SSD	No	4
4XB7A17119	BA7L	ThinkSystem 3.5" S4520 480GB Read Intensive SATA 6Gb HS SSD	No	4
4XB7A17120	BA7M	ThinkSystem 3.5" S4520 960GB Read Intensive SATA 6Gb HS SSD	No	4
4XB7A17121	BA7N	ThinkSystem 3.5" S4520 1.92TB Read Intensive SATA 6Gb HS SSD	No	4
4XB7A17122	BK7F	ThinkSystem 3.5" S4520 3.84TB Read Intensive SATA 6Gb HS SSD	No	4
4XB7A17123	BK7G	ThinkSystem 3.5" S4520 7.68TB Read Intensive SATA 6Gb HS SSD	No	4
4XB7A38276	BCTH	ThinkSystem 3.5" Multi Vendor 240GB Entry SATA 6Gb Hot Swap SSD	No	4
4XB7A38278	BCTK	ThinkSystem 3.5" Multi Vendor 960GB Entry SATA 6Gb Hot Swap SSD	No	4
4XB7A38279	BCTL	ThinkSystem 3.5" Multi Vendor 1.92TB Entry SATA 6Gb Hot Swap SSD	No	4
4XB7A38281	BCTM	ThinkSystem 3.5" Multi Vendor 3.84TB Entry SATA 6Gb Hot Swap SSD	No	4
4XB7A17081	B8JB	ThinkSystem 3.5" 5300 240GB Entry SATA 6Gb Hot Swap SSD	No	4
4XB7A17086	B8J3	ThinkSystem 3.5" 5300 7.68TB Entry SATA 6Gb Hot Swap SSD	No	4

Table 44. M.2 SATA drives

Part number	Feature code	Description	SED support	Max Qty
M.2 SSDs - 6 Gb SATA - Read Intensive/Entry (<3 DWPD)				
4XB7A82286	BQ1Z	ThinkSystem M.2 5400 PRO 240GB Read Intensive SATA 6Gb NHS SSD	Support	2
4XB7A82287	BQ1Y	ThinkSystem M.2 5400 PRO 480GB Read Intensive SATA 6Gb NHS SSD	Support	2
4XB7A82288	BQ20	ThinkSystem M.2 5400 PRO 960GB Read Intensive SATA 6Gb NHS SSD	Support	2
7N47A00129	AUUL	ThinkSystem M.2 32GB SATA 6Gbps Non-Hot Swap SSD	No	2
7N47A00130	AUUV	ThinkSystem M.2 128GB SATA 6Gbps Non-Hot Swap SSD	No	2
4XB7A17074	B8JJ	ThinkSystem M.2 5300 960GB SATA 6Gbps Non-Hot Swap SSD	No	2

Internal backup units

The server does not support any internal backup units, such as tape drives or RDX drives. External backup units are available as described in the [External backup units](#) section.

Optical drives

The server supports the external USB optical drive listed in the following table.

Table 45. External optical drive

Part number	Feature code	Description
7XA7A05926	AVV8	ThinkSystem External USB DVD RW Optical Disk Drive

The drive is based on the Lenovo Slim DVD Burner DB65 drive and supports the following formats: DVD-RAM, DVD-RW, DVD+RW, DVD+R, DVD-R, DVD-ROM, DVD-R DL, CD-RW, CD-R, CD-ROM.

I/O expansion

The server supports a total of up to 4 PCIe 4.0 slots (3 with rear access, 1 internal for a RAID adapter or HBA) plus a dedicated OCP 3.0 SFF slot for networking. Slot availability is based on riser selection.

- Slot 1: PCIe 4.0 x16 LP or FHHL
- Slot 2: PCIe 4.0 x16 LP (not present if slot 1 is FHHL or rear drive bays are present)
- Slot 3: PCIe 4.0 x16 LP (not present if rear drive bays are present)
- Slot 4: PCIe 4.0 x8 LP (internal slot; physically a x16 slot)

The following figure shows the locations of the rear-accessible slots for each configuration selection. The OCP slot is located in the lower-left corner.

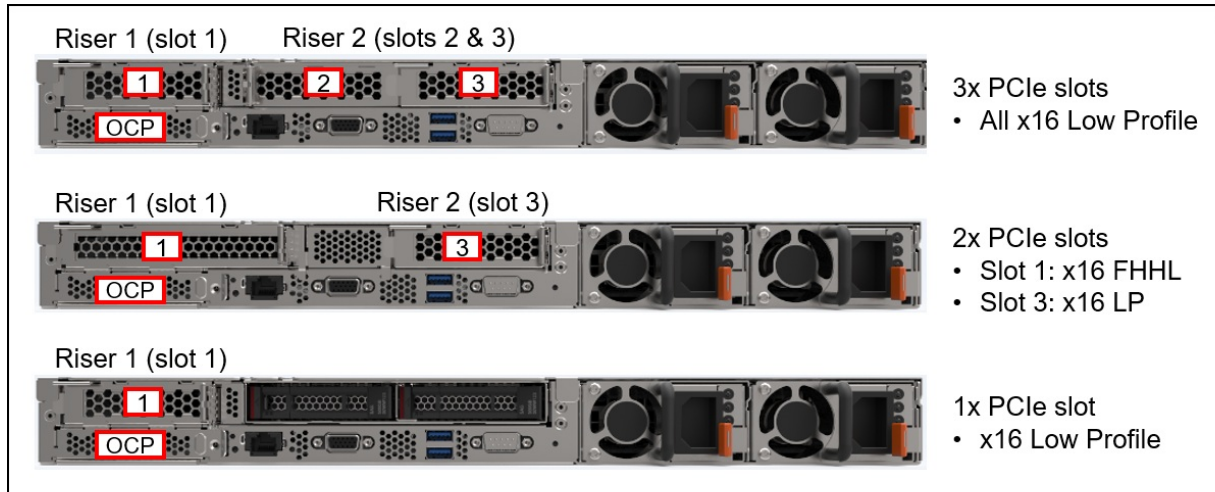

Figure 11. SR635 slots

The slots and riser cards are as follows:

- Riser 1: Slot 1 (PCIe x16)
 - Slot 1: Low Profile or FHHL, PCIe 4.0 x16 slot
- Riser 2: Slots 2 & 3 (each PCIe x16)
 - Slot 2: Low Profile, PCIe 4.0 x16 (only available in 3x LP slot configuration)
 - Slot 3: Low Profile, PCIe 4.0 x16 (not available in configurations with rear drive bays)
- Internal Riser: Slot 4 (PCIe x8)
 - Low Profile PCIe 4.0 x8 slot for internal drive controller (physically a x16 slot)

The riser cards and slot brackets used to provide the above slot combinations in configure-to-order (CTO) configurations are listed in the following table.

Tip: It is also possible to not have any slot selections, in which case slot fillers will be derived in the configurator. Slots can be added later as field upgrades using option part numbers.

Table 46. Riser slot selections - Feature codes for CTO

Feature code	Description	Maximum Supported	Purpose
Riser 1			
B5VV	ThinkSystem SR635/SR655 x16 PCIe Riser1	1	Riser for slot 1
B5WZ	ThinkSystem SR635/SR655 MS FH Riser BKT	1	FHHL slot bracket for slot 1
B5WD	ThinkSystem SR635 MS LP Riser BKT Slot1	1	Low Profile slot bracket for slot 1
Riser 2			
B5W0	ThinkSystem SR635/SR655 x16/x16 PCIe Riser2 (BF)	1	Riser for slots 2 & 3
B5X4	ThinkSystem SR635 MS LP+LP BF Riser BKT	1	Low Profile brackets for slots 2 & 3
B715	ThinkSystem SR635 MS LP Riser BKT Slot3	1	Low Profile bracket for slot 3
Internal			
B5VW	ThinkSystem SR635/SR655 x8 PCIe Internal Riser	1	Riser for Internal slot
B5WN	ThinkSystem SR635/SR655 Internal Riser BKT	1	Internal slot bracket

Slot configurations can also be ordered as field upgrades using option part numbers, as listed in the following table.

Table 47. Field upgrades for PCIe slots

Part number	Description	Maximum Supported
4XH7A09835	ThinkSystem SR635/SR655 x16 PCIe 1U Riser 1 Kit <ul style="list-style-type: none"> ● PCIe 4.0 x16 riser card, installs in riser slot 1, one x16 slot ● Bracket for slot 1 as a FHHL slot ● Bracket for slot 1 as a Low Profile slot 	1
4XH7A09836	ThinkSystem SR635/SR655 x16/x16 PCIe Riser2 LP Kit <ul style="list-style-type: none"> ● PCIe 4.0 x16 riser card, installs in riser slot 2, with two x16 slots ● Bracket for slots 2 & 3 (use if slot 1 is a LP slot) ("butterfly" bracket) ● Bracket for slot 3 only (use if slot 1 is a FHHL slot; slot 2 is inaccessible) 	1
4XH7A09843	ThinkSystem SR635/SR655 x8 PCIe Internal Riser Kit <ul style="list-style-type: none"> ● PCIe 4.0 x8 riser for internal slot ● Low profile riser bracket for internal slot ● 2x supercap brackets 	1

Network adapters

The server has a dedicated OCP 3.0 SFF slot with PCIe 4.0 x16 host interface. See [Figure 3](#) for the location of the OCP slot.

The following table lists the supported OCP adapters. One port can optionally be shared with the ASPEED management processor for Wake-on-LAN and NC-SI support. Only 1 OCP card can be installed in the server.

Table 48. Supported OCP adapters

Part number	Feature code	Description
Gigabit		
4XC7A08235	B5T1	ThinkSystem Broadcom 5719 1GbE RJ45 4-port OCP Ethernet Adapter
4XC7A08277	B93E	ThinkSystem Intel I350 1GbE RJ45 4-port OCP Ethernet Adapter
10 GbE		
4XC7A08236	B5ST	ThinkSystem Broadcom 57416 10GBASE-T 2-port OCP Ethernet Adapter
4XC7A08239	B5SS	ThinkSystem Broadcom 57416 10GBASE-T 2-port + 5720 1GbE 2-port OCP Ethernet Adapter
4XC7A08240	B5T4	ThinkSystem Broadcom 57454 10GBASE-T 4-port OCP Ethernet Adapter
4XC7A08278	BCD5	ThinkSystem Intel X710-T2L 10GBASE-T 2-port OCP Ethernet Adapter
4XC7A80268	BPPY	ThinkSystem Intel X710-T4L 10GBase-T 4-Port OCP Ethernet Adapter
4XC7A08310	BB8U	ThinkSystem Marvell QL41132 10GBASE-T 2-port OCP Ethernet Adapter
25 GbE		
4XC7A08237	B5SZ	ThinkSystem Broadcom 57414 10/25GbE SFP28 2-port OCP Ethernet Adapter
4XC7A08242	B5SV	ThinkSystem Broadcom 57454 10/25GbE SFP28 4-port OCP Ethernet Adapter
4XC7A08294	BCD4	ThinkSystem Intel E810-DA2 10/25GbE SFP28 2-Port OCP Ethernet Adapter
4XC7A80269	BP8L	ThinkSystem Intel E810-DA4 10/25GbE SFP28 4-Port OCP Ethernet Adapter
4XC7A08246	B5T2	ThinkSystem Mellanox ConnectX-4 Lx 10/25GbE SFP28 2-port OCP Ethernet Adapter
4XC7A62582	BE4T	ThinkSystem Mellanox ConnectX-6 Lx 10/25GbE SFP28 2-Port OCP Ethernet Adapter

Installation & removal: Before installing or removing an OCP adapter, power off your server and disconnect power cords first. See [Support tip HT509768](#) for details.

For more information, including the transceivers and cables that each adapter supports, see the list of Lenovo Press Product Guides in the Networking adapters category:
<https://lenovopress.com/servers/options/ethernet>

The following table lists additional supported network adapters that can be installed in the regular PCIe slots.

Table 49. Supported PCIe Network Adapters

Part number	Feature code	Description	Slots supported	Maximum supported
Gigabit Ethernet				
7ZT7A00484	AUZV	ThinkSystem Broadcom 5719 1GbE RJ45 4-Port PCIe Ethernet Adapter	1, 3, 2	3
7ZT7A00482	AUZX	ThinkSystem Broadcom 5720 1GbE RJ45 2-Port PCIe Ethernet Adapter	1, 3, 2	3
7ZT7A00534	AUZY	ThinkSystem I350-T2 PCIe 1Gb 2-Port RJ45 Ethernet Adapter	1, 3, 2	3
7ZT7A00535	AUZW	ThinkSystem I350-T4 PCIe 1Gb 4-Port RJ45 Ethernet Adapter	1, 3, 2	3
10 GbE				

Part number	Feature code	Description	Slots supported	Maximum supported
7ZT7A00496	AUKP	ThinkSystem Broadcom 57416 10GBASE-T 2-Port PCIe Ethernet Adapter	1, 3, 2	3
4XC7A08245	B5SU	ThinkSystem Broadcom 57454 10GBASE-T 4-port PCIe Ethernet Adapter	1, 3, 2*	3
00MM860	ATPX	Intel X550-T2 Dual Port 10GBase-T Adapter	1, 3, 2	3
7ZT7A00537	AUKX	ThinkSystem Intel X710-DA2 PCIe 10Gb 2-Port SFP+ Ethernet Adapter	1, 3, 2*	3
4XC7A80266	BNWL	ThinkSystem Intel X710-T2L 10GBase-T 2-Port PCIe Ethernet Adapter	1, 3, 2	3
4XC7A79699	BMXB	ThinkSystem Intel X710-T4L 10GBase-T 4-Port PCIe Ethernet Adapter	1, 3, 2	3
4XC7A08225	B31G	ThinkSystem QLogic QL41134 PCIe 10Gb 4-Port Base-T Ethernet Adapter	1, 3, 2	3
25 GbE				
4XC7A08238	B5T0	ThinkSystem Broadcom 57414 10/25GbE SFP28 2-port PCIe Ethernet Adapter	1, 3, 2*	3
4XC7A08316	BD49	ThinkSystem Broadcom 57454 10/25GbE SFP28 4-port PCIe Ethernet Adapter V2	1*	1†
4XC7A08295	BCD6	ThinkSystem Intel E810-DA2 10/25GbE SFP28 2-Port PCIe Ethernet Adapter	1, 3, 2*	3
4XC7A80267	BP8M	ThinkSystem Intel E810-DA4 10/25GbE SFP28 4-Port PCIe Ethernet Adapter	1	1†
4XC7A08270	B652	ThinkSystem Marvell QL41232 10/25GbE SFP28 2-Port PCIe Ethernet Adapter	1, 3, 2*	3
4XC7A08249	B653	ThinkSystem Mellanox ConnectX-4 Lx 10/25GbE SFP28 2-port PCIe Ethernet Adapter	1, 3, 2*	3
4XC7A62580	BE4U	ThinkSystem Mellanox ConnectX-6 Lx 10/25GbE SFP28 2-Port PCIe Ethernet Adapter	1, 3, 2*	3
100 GbE				
4XC7A08297	BK1J	ThinkSystem Broadcom 57508 100GbE QSFP56 2-port PCIe 4 Ethernet Adapter	1, 3, 2*	3**
4XC7A08248	B8PP	ThinkSystem Mellanox ConnectX-6 Dx 100GbE QSFP56 2-port PCIe Ethernet Adapter	1, 3, 2*	3**
InfiniBand				
4C57A14177	B4R9	ThinkSystem Mellanox ConnectX-6 HDR100/100GbE QSFP56 1-port PCIe VPI Adapter	1, 3, 2*	3**
4C57A14178	B4RA	ThinkSystem Mellanox ConnectX-6 HDR100/100GbE QSFP56 2-port PCIe VPI Adapter	1, 3, 2*	3**
4C57A15326	B4RC	ThinkSystem Mellanox ConnectX-6 HDR/200GbE QSFP56 1-port PCIe 4 VPI Adapter	1, 3, 2*	3**

* Not supported in slot 2 when a 280W processor is installed

** See thermal requirements below

† In the SR635, this adapter requires a full-height bracket and must be installed in a full-height slot. The use of a low-profile bracket and slot is not supported.

The following thermal requirement apply to HDR/HDR100 InfiniBand and 100/200Gb Ethernet adapters:

- The high performance cooling fans must be installed. See the [Cooling](#) section for details.
- Ambient temperature cannot be greater than 35°C (if the processor TDP is 155W or lower) or 30°C (for 180W or higher processors)

For more information, including the transceivers and cables that each adapter supports, see the list of Lenovo Press Product Guides in the Networking adapters category:
<https://lenovopress.com/servers/options/ethernet>

Fibre Channel host bus adapters

The following table lists the Fibre Channel HBAs supported by the SR635.

Note that the Emulex LPe35000 adapters are supported either with EPYC 7002 "Rome" processors or with EPYC 7003 "Milan" processors, as indicated in the table.

Table 50. Fibre Channel HBAs

Part number	Feature code	Description	EPYC 7002	EPYC 7003	Slots supported	Maximum supported
32 Gb Fibre Channel HBAs						
4XC7A08250	B5SX	ThinkSystem Emulex LPe35000 32Gb 1-port PCIe Fibre Channel Adapter	Yes	No	1, 3, 2*	3
4XC7A08251	B5SY	ThinkSystem Emulex LPe35002 32Gb 2-port PCIe Fibre Channel Adapter	Yes	No	1, 3, 2*	3
4XC7A76498	BJ3G	ThinkSystem Emulex LPe35000 32Gb 1-port PCIe Fibre Channel Adapter v2	No	Yes	1, 3, 2*	3
4XC7A76525	BJ3H	ThinkSystem Emulex LPe35002 32Gb 2-port PCIe Fibre Channel Adapter V2	No	Yes	1, 3, 2*	3
4XC7A08279	BA1G	ThinkSystem QLogic QLE2770 32Gb 1-Port PCIe Fibre Channel Adapter	Yes	Yes	1, 3, 2*	3
4XC7A08276	BA1F	ThinkSystem QLogic QLE2772 32Gb 2-Port PCIe Fibre Channel Adapter	Yes	Yes	1, 3, 2*	3
7ZT7A00516	AUNS	ThinkSystem QLogic QLE2740 PCIe 32Gb 1-Port SFP+ Fibre Channel Adapter	Yes	Yes	1, 3, 2*	3
7ZT7A00518	AUNU	ThinkSystem QLogic QLE2742 PCIe 32Gb 2-Port SFP+ Fibre Channel Adapter	Yes	Yes	1, 3, 2*	3
16 Gb Fibre Channel HBAs						
01CV840	ATZV	Emulex 16Gb Gen6 FC Dual-port HBA	Yes	Yes	1, 3, 2*	3
01CV830	ATZU	Emulex 16Gb Gen6 FC Single-port HBA	Yes	Yes	1, 3, 2*	3
01CV760	ATZC	QLogic 16Gb Enhanced Gen5 FC Dual-port HBA	Yes	Yes	1, 3, 2*	3
01CV750	ATZB	QLogic 16Gb Enhanced Gen5 FC Single-port HBA	Yes	Yes	1, 3, 2*	3

* Not supported in slot 2 when a 280W processor is installed

For more information, see the list of Lenovo Press Product Guides in the Host bus adapters category:
<https://lenovopress.com/servers/options/hba>

SAS adapters for external storage

The following table lists SAS HBAs and RAID adapters supported by SR635 server for use with external storage.

Table 51. Adapters for external storage

Part number	Feature code	Description	Slots supported	Maximum supported
SAS HBAs				
7Y37A01090	AUNR	ThinkSystem 430-8e SAS/SATA 12Gb HBA	1, 3, 2	3
7Y37A01091	AUNN	ThinkSystem 430-16e SAS/SATA 12Gb HBA	1, 3, 2	3
4Y37A78837	BNWK	ThinkSystem 440-8e SAS/SATA PCIe Gen4 12Gb HBA	1, 3, 2	3
4Y37A09724	B8P7	ThinkSystem 440-16e SAS/SATA PCIe Gen4 12Gb HBA	1, 3, 2	3
External RAID adapters				
7Y37A01087	AUNQ	ThinkSystem RAID 930-8e 4GB Flash PCIe 12Gb Adapter	1, 3, 2	3*
4Y37A78836	BNWJ	ThinkSystem RAID 940-8e 4GB Flash PCIe Gen4 12Gb Adapter	1, 3, 2	3*

* See configuration rules below

Mixing storage adapter families: The following HBA/RAID adapter combinations are supported:

- X30 external adapters with other X30 adapters (internal or external)
- X40 external adapters with other X40 adapters (internal or external)
- X40 external adapters with X350 internal adapters

The following HBA/RAID adapter combinations are *not* supported:

- X30 adapters (internal or external) with X40 adapters (internal or external)
- X30 adapters (internal or external) with X350 internal adapters

Configuration rules

The RAID 930-8e and RAID 940-8e use a flash power module (supercap), which can be installed in one of 3 locations as shown in the following figure.

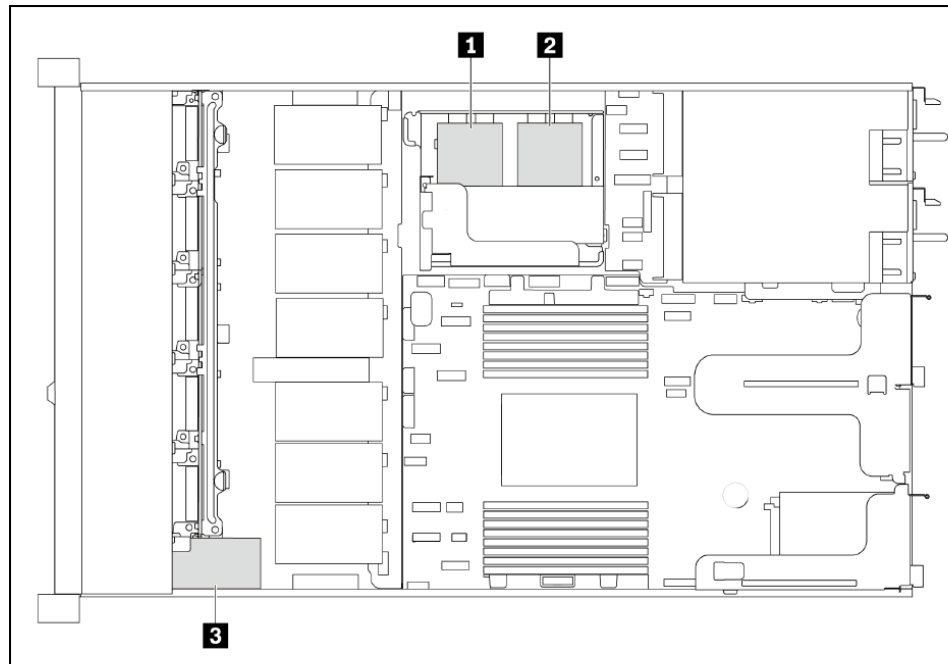

Figure 12. Location of all three supercaps in the SR635 (2.5-inch drive configuration)

The number of supercap locations is reduced depending on installed components:

- For configurations with 2.5-inch front drives and no mid drive cage, 3x 930/940-8e adapters and supercaps can be installed (locations 1, 2, and 3).
- For configurations with 2.5-inch front drives and a mid drive cage installed, 1x 930/940-8e adapter and supercap can be installed (location 3 only).
- For configurations with 3.5-inch front drives, and no mid drive cage, 2x 930/940-8e adapters and supercaps can be installed (location 1 and 2; location 3 is not present).
- For configurations with 3.5-inch front drives and a mid drive cage installed, no 930/940-8e adapters and supercaps can be installed.
- If any internal RAID adapters with flash power modules are installed, the maximum number of 930/940-8e adapters supported is further reduced by that number.

For more information, see the list of Lenovo Press Product Guides in the Host bus adapters and RAID adapters categories:

<https://lenovopress.com/servers/options/hba>

<https://lenovopress.com/servers/options/raid>

The following table compares the specifications of the external SAS HBAs and RAID adapters.

Table 52. Comparison of external storage adapters

Feature	430-8e	430-16e	930-8e
Adapter type	HBA	HBA	External RAID
Part number	7Y37A01090	7Y37A01091	7Y37A01087
Controller chip	LSI SAS3408	LSI SAS3416	LSI SAS3516
Broadcom equivalent	HBA 9400-8e	HBA 9400-16e	MegaRAID 9480-8e
Host interface	PCIe 3.0x8	PCIe 3.0x8	PCIe 3.0x8
Port interface	12 Gb SAS	12 Gb SAS	12 Gb SAS
Number of ports	8	16	8
Port connectors	2x Mini-SAS HD SFF8644	4x Mini-SAS HD SFF8644	2x Mini-SAS HD SFF8644
Drive interface	SAS/SATA	SAS/SATA	SAS,SATA
Drive type	HDD/SSD/SED*	HDD/SSD/SED*	HDD,SED,SSD
Hot-swap drives	Yes	Yes	Yes
Maximum devices	1024	1024	216
RAID levels	None	None	0/1/10/5/50/6/60
JBOD mode	Yes	Yes	Yes
Cache	None	None	4GB (Standard)
CacheVault cache protection	None	None	Yes (Flash)
Performance Accelerator (FastPath)	No	No	Yes
SSD Caching (CacheCade Pro 2.0)	No	No	No
SED support*	Yes	Yes	Yes

* SAS HBAs support SEDs (self-encrypting drives) by using software on the server and simply passing SED commands through the HBA to the drives. SED support by RAID controllers is provided using the built-in MegaRAID SafeStore functionality of the adapter.

Flash storage adapters

The SR635 supports the PCIe Flash Storage adapters listed in the following table.

Table 53. Flash Storage Adapters

Part number	Feature code	Description	Slots supported	Maximum supported
Mainstream NVMe PCIe Adapters - Optimized for mixed-intensive application workloads with an endurance of 3-5 DWPD.				
4XB7A38240	BCGL	ThinkSystem HHHH Kioxia CM5-V 6.4TB Mainstream NVMe PCIe3.0 x4 Flash Adapter	1, 3, 2	3
4XB7A14075	B8JH	ThinkSystem HHHH PM1735 1.6TB Mainstream NVMe PCIe 4.0 x8 Flash Adapter	1, 3, 2	3
4XB7A14076	B8HW	ThinkSystem HHHH PM1735 3.2TB Mainstream NVMe PCIe 4.0 x8 Flash Adapter	1, 3, 2	3
4XB7A14077	B96M	ThinkSystem HHHH PM1735 6.4TB Mainstream NVMe PCIe4.0 x8 Flash Adapter	1, 3, 2	3

For details about these adapters, see the Lenovo Press product guides in the Flash Adapters category: <https://lenovopress.com/servers/options/ssdadapter>

Configuration rules

The following configuration requirements must be met when installing flash storage adapters:

- GPU adapters are not supported
- Maximum processor TDP is 155W
- Performance fans are required and will be derived by the configurator for configure-to-order builds.
- When adding Flash adapters as field upgrades, you will be required to replace all standard fans with performance fan modules. The ordering part number is listed in the following table - you will be required to order 7 fans.

Table 54. Performance fan ordering information

Part number	Feature code	Description	Quantity required
4F17A14483	B5X0	ThinkSystem SR635 Performance Fan Module	7

GPU adapters

The SR635 supports the following graphics processing units (GPUs).

Table 55. Supported GPUs

Part number	Feature code	Description	Slots supported	Maximum supported
4X67A81547	BP05	ThinkSystem NVIDIA A2 16GB PCIe Gen4 Passive GPU	1, 3, 2	3
CTO only	BQZT	ThinkSystem NVIDIA A2 16GB PCIe Gen4 Passive GPU w/o CEC	1, 3, 2	3
4X67A14926	B4YB	ThinkSystem NVIDIA T4 16GB PCIe Passive GPU	1, 3, 2	3

For information about these GPUs, see the ThinkSystem GPU Summary, available at: <https://lenovopress.com/lp0768-thinksystem-thinkagile-gpu-summary>

Configuration rules

The following configuration requirements must be met when installing GPUs:

- Some NVIDIA A Series GPUs are available as two feature codes, one with a CEC chip and one without a CEC chip (ones without the CEC chip have "w/o CEC" in the name). The CEC is a secondary Hardware Root of Trust (RoT) module that provides an additional layer of security, which can be used by customers who have high regulatory requirements or high security standards. NVIDIA uses a multi-layered security model and hence the protection offered by the primary Root of Trust embedded in the GPU is expected to be sufficient for most customers. The CEC defeatured products still offer Secure Boot, Secure Firmware Update, Firmware Rollback Protection, and In-Band Firmware Update Disable. Specifically, without the CEC chip, the GPU does not support Key Revocation or Firmware Attestation. CEC and non-CEC GPUs of the same type of GPU can be mixed in field upgrades.
- All GPUs installed must be identical
- Rear drive bays and mid-chassis drive bays are not supported.
- Flash storage adapters are not supported.
- 1100W power supplies (or in some configurations, 750W power supplies) are required.
- If the intrusion switch is installed, then only two GPUs can be installed, in slots 2 and 3. The intrusion switch and a GPU in slot 1 are mutually exclusive.

Additional rules when installing T4 GPUs:

- With two GPUs installed, processor TDP greater than 200W not supported
 - If ambient temperature is 35°C, then processor TDP greater than 120W not supported
 - If ambient temperature is 30°C, then processor TDP greater than 200W not supported
- With three GPUs installed, processor TDP greater than 120W not supported
- The following additional drive backplane rules apply if 3 GPUs are installed (rules do not apply if only 2 GPUs installed):
 - 3.5-inch drive bay backplane (AUW8) is fully supported
 - 8x 2.5-inch drive backplane (B7K3) supported, however 2 drive bays (6, 7) must be empty
 - 6x 2.5-inch SAS/SATA + 4x AnyBay backplane (AUW9) supported, however all AnyBay bays (6, 7, 8, 9) must be empty
 - 10x 2.5-inch AnyBay backplane (B5VS), however 4 bays (6, 7, 8, 9) must be empty
 - Ambient temperature great than 30°C is not supported
 - Processor TDP greater than 120W is not supported

Additional rules when installing any quantity of P620 GPUs:

- All front drive bay configurations are supported
- Ambient temperature great than 35°C is not supported
- Processor TDP greater than 240W is not supported

GPU field upgrades

When ordering GPUs as part of a CTO configuration, the necessary cooling features are automatically selected as part of the order. However when ordering the GPUs as field upgrades, you will need to also order 7 performance fans which will replace the standard fans already installed. 7 part numbers will need to be ordered per server.

Table 56. Performance fan ordering information

Part number	Description	Quantity required
4F17A14483	ThinkSystem SR635 Performance Fan Module	7

When a GPU is added as a field upgrade, all empty DIMM slots must have a dummy DIMM blank installed in each DIMM slot, to ensure the optimal air flow. Ordering information is in the following table.

Table 57. ThinkSystem Dummy DIMM Kit

Part number	Description	Quantity required
4M27A11810	ThinkSystem Dummy DIMM Package Kit (contains 24 dummy memory DIMMs)	1

Cooling

The SR635 server has seven 40 mm dual-rotor hot-swap variable-speed fans and either 6 or 7 fans are standard depending on the configuration. The fans are dual-rotor counter-rotating units, which means that the fans have two separate propellers, one in front of the other, and that the propellers rotate in opposite directions. The server offers N+1 redundancy. The server also has one additional fan integrated in each of the two power supplies.

Under all of the following conditions, only 6 fans are required:

- No M.2 Module
- No internal riser slot
- No mid drive bays
- No rear drives
- No GPUs

For all other configurations, all 7 fans are required.

Table 58. Fan ordering information

Part number	Feature code	Description	Maximum supported
4F17A12358	B5X1	ThinkSystem SR635 1U Fan Module	7
4F17A14483	B5X0	ThinkSystem SR635 Performance Fan Module	7

Some configurations, such as the use of high-TDP processors, GPUs, flash storage adapters, mid drive or rear drives, or Ethernet/InfiniBand adapters of 100Gb or higher, will require the use of high performance fans which have higher RPMs. For configure-to-order builds, the DCSC configurator will automatically select the required fans. For field upgrades, the option part numbers may include the upgraded components when they are needed, or you may need to order the performance fans separately.

See these sections for details:

- [Drive bay upgrade kits](#)
- [GPU upgrade kits](#)
- [Flash storage adapters](#)
- [PCIe network adapters](#)

Power supplies

The server supports up to two redundant hot-swap power supplies.

The power supply choices are listed in the following table. Both power supplies used in server must be identical.

Tip: Use Lenovo Capacity Planner to determine exactly what power your server needs:
<https://datacentersupport.lenovo.com/us/en/solutions/invo-lcp>

Table 59. Power supply options

Part number	Feature code	Description	Maximum supported	110V AC	220V AC	240V DC China only	-48V DC
AC power input							
7N67A00882	AVWC	ThinkSystem 550W(230V/115V) Platinum Hot-Swap Power Supply	2	Yes	Yes	Yes	No
7N67A00883	B6XT	ThinkSystem 750W(230/115V) Platinum Hot-Swap Power Supply	2	Yes	Yes	Yes	No
7N67A00884	B6XS	ThinkSystem 750W (230V) Titanium Hot-Swap Power Supply	2	No	Yes	Yes	No
4P57A82020	BR1Y	ThinkSystem V1 750W (230Vac) Titanium Hot Swap Power Supply	2	No	Yes	Yes	No
7N67A00885	AVWF	ThinkSystem 1100W (230V/115V) Platinum Hot-Swap Power Supply	2	Yes	Yes	Yes	No
-48V DC input power							
4P57A15363*	B4Z5*	ThinkSystem 1100W -48V DC Power Supply	2	No	No	No	Yes

* -48V DC power supply is only available via Special Bid

Dual-voltage power supplies are auto-sensing and support both 110V AC (100-127V 50/60 Hz) and 220V AC (200-240V 50/60 Hz) power. For China customers, all AC power supplies support 240V DC.

All supported AC power supplies have a C14 connector. The -48V DC power supply has a Positronic PLB3W3M1000/AA connector.

Power supply options do not include a line cord.

For server configurations, the inclusion of a power cord is model dependent. Configure-to-order models can be configured without power cords if desired.

Power cords

Line cords and rack power cables with C13 connectors can be ordered as listed in the following table.

110V customers: If you plan to use the 1100W power supply with a 110V power source, select a power cable that is rated above 10A. Power cables that are rated at 10A or below are not supported with 110V power.

Table 60. Power cords

Part number	Feature code	Description
Rack cables - C13 to C14		

Part number	Feature code	Description
SL67B08593	BPHZ	0.5m, 10A/100-250V, C13 to C14 Jumper Cord
00Y3043	A4VP	1.0m, 10A/100-250V, C13 to IEC 320-C14 Rack Power Cable
4L67A08367	B0N5	1.0m, 13A/100-250V, C13 to C14 Jumper Cord
39Y7937	6201	1.5m, 10A/100-250V, C13 to IEC 320-C14 Rack Power Cable
4L67A08368	B0N6	1.5m, 13A/100-250V, C13 to C14 Jumper Cord
4L67A08365	B0N4	2.0m, 10A/100-250V, C13 to IEC 320-C14 Rack Power Cable
4L67A08369	6570	2.0m, 13A/100-250V, C13 to C14 Jumper Cord
4L67A08366	6311	2.8m, 10A/100-250V, C13 to IEC 320-C14 Rack Power Cable
4L67A08370	6400	2.8m, 13A/100-250V, C13 to C14 Jumper Cord
39Y7932	6263	4.3m, 10A/100-250V, C13 to IEC 320-C14 Rack Power Cable
4L67A08371	6583	4.3m, 13A/100-250V, C13 to C14 Rack Power Cable
Rack cables - C13 to C14 (Y-cable)		
00Y3046	A4VQ	1.345m, 2X C13 to C14 Jumper Cord, Rack Power Cable
00Y3047	A4VR	2.054m, 2X C13 to C14 Jumper Cord, Rack Power Cable
Rack cables - C13 to C20		
39Y7938	6204	2.8m, 10A/100-250V, C13 to IEC 320-C20 Rack Power Cable
Rack cables - C13 to C20 (Y-cable)		
47C2491	A3SW	1.2m, 16A/100-250V, 2 Short C13s to Short C20 Rack Power Cable
47C2492	A3SX	2.5m, 16A/100-250V, 2 Long C13s to Short C20 Rack Power Cable
47C2493	A3SY	2.8m, 16A/100-250V, 2 Short C13s to Long C20 Rack Power Cable
47C2494	A3SZ	4.1m, 16A/100-250V, 2 Long C13s to Long C20 Rack Power Cable
Line cords		
39Y7930	6222	2.8m, 10A/250V, C13 to IRAM 2073 (Argentina) Line Cord
81Y2384	6492	4.3m 10A/220V, C13 to IRAM 2073 (Argentina) Line Cord
39Y7924	6211	2.8m, 10A/250V, C13 to AS/NZ 3112 (Australia/NZ) Line Cord
81Y2383	6574	4.3m, 10A/230V, C13 to AS/NZS 3112 (Aus/NZ) Line Cord
69Y1988	6532	2.8m, 10A/250V, C13 to NBR 14136 (Brazil) Line Cord
81Y2387	6404	4.3m, 10A/250V, C13 - 2P+Gnd (Brazil) Line Cord
39Y7928	6210	2.8m, 220-240V, C13 to GB 2099.1 (China) Line Cord
81Y2378	6580	4.3m, 10A/220V, C13 to GB 2099.1 (China) Line Cord
39Y7918	6213	2.8m, 10A/250V, C13 to DK2-5a (Denmark) Line Cord
81Y2382	6575	4.3m, 10A/230V, C13 to DK2-5a (Denmark) Line Cord
39Y7917	6212	2.8m, 10A/230V, C13 to CEE7-VII (Europe) Line Cord
81Y2376	6572	4.3m, 10A/230V, C13 to CEE7-VII (Europe) Line Cord
39Y7927	6269	2.8m, 10A/250V, C13(2P+Gnd) (India) Line Cord
81Y2386	6567	4.3m, 10A/240V, C13 to IS 6538 (India) Line Cord
39Y7920	6218	2.8m, 10A/250V, C13 to SI 32 (Israel) Line Cord
81Y2381	6579	4.3m, 10A/230V, C13 to SI 32 (Israel) Line Cord
39Y7921	6217	2.8m, 220-240V, C13 to CEI 23-16 (Italy/Chile) Line Cord
81Y2380	6493	4.3m, 10A/230V, C13 to CEI 23-16 (Italy/Chile) Line Cord
46M2593	A1RE	2.8m, 12A/125V, C13 to JIS C-8303 (Japan) Line Cord

Part number	Feature code	Description
4L67A08362	6495	4.3m, 12A/200V, C13 to JIS C-8303 (Japan) Line Cord
39Y7926	6335	4.3m, 12A/100V, C13 to JIS C-8303 (Japan) Line Cord
39Y7922	6214	2.8m, 10A/250V, C13 to SABS 164 (S Africa) Line Cord
81Y2379	6576	4.3m, 10A/230V, C13 to SABS 164 (South Africa) Line Cord
39Y7925	6219	2.8m, 220-240V, C13 to KETI (S Korea) Line Cord
81Y2385	6494	4.3m, 12A/220V, C13 to KSC 8305 (S. Korea) Line Cord
39Y7919	6216	2.8m, 10A/250V, C13 to SEV 1011-S24507 (Swiss) Line Cord
81Y2390	6578	4.3m, 10A/230V, C13 to SEV 1011-S24507 (Sws) Line Cord
23R7158	6386	2.8m, 10A/125V, C13 to CNS 10917-3 (Taiwan) Line Cord
81Y2375	6317	2.8m, 10A/240V, C13 to CNS 10917-3 (Taiwan) Line Cord
81Y2374	6402	2.8m, 13A/125V, C13 to CNS 60799 (Taiwan) Line Cord
4L67A08363	AX8B	4.3m, 10A 125V, C13 to CNS 10917 (Taiwan) Line Cord
81Y2389	6531	4.3m, 10A/250V, C13 to 76 CNS 10917-3 (Taiwan) Line Cord
81Y2388	6530	4.3m, 13A/125V, C13 to CNS 10917 (Taiwan) Line Cord
39Y7923	6215	2.8m, 10A/250V, C13 to BS 1363/A (UK) Line Cord
81Y2377	6577	4.3m, 10A/230V, C13 to BS 1363/A (UK) Line Cord
90Y3016	6313	2.8m, 10A/120V, C13 to NEMA 5-15P (US) Line Cord
46M2592	A1RF	2.8m, 10A/250V, C13 to NEMA 6-15P Line Cord
00WH545	6401	2.8m, 13A/120V, C13 to NEMA 5-15P (US) Line Cord
4L67A08359	6370	4.3m, 10A/125V, C13 to NEMA 5-15P (US) Line Cord
4L67A08361	6373	4.3m, 10A/250V, C13 to NEMA 6-15P (US) Line Cord
4L67A08360	AX8A	4.3m, 13A/120V, C13 to NEMA 5-15P (US) Line Cord

For the -48V DC Power Supply, the following power cable is supported.

Table 61. -48V DC power cable

Part number	Feature code	Description
CTO only	B93F	ThinkSystem 2.5m,DC Cable

Integrated virtualization

The server supports booting from an operating system or hypervisor installed on an M.2 solid-state drive. See the [M.2 drives section](#) for details and the list of available options.

You can download supported VMware vSphere hypervisor images from the following web page and load it on the M.2 drive using the instructions provided:

https://vmware.lenovo.com/content/custom_iso/

Systems management

The server contains an integrated service processor which provides advanced control, monitoring, and alerting functions. The service processor is based on the ASPEED AST2500 baseboard management controller (BMC).

- [Local management](#)
- [Remote management](#)

- [Lenovo XClarity Administrator](#)
- [Lenovo XClarity Provisioning Manager Lite](#)
- [Lenovo XClarity Essentials](#)
- [Lenovo XClarity Energy Manager](#)

Local management

The SR635 offers a front operator panel with key LED status indicators, as shown in the following figure.

Tip: The Network LED only shows network activity of the installed OCP network adapter.

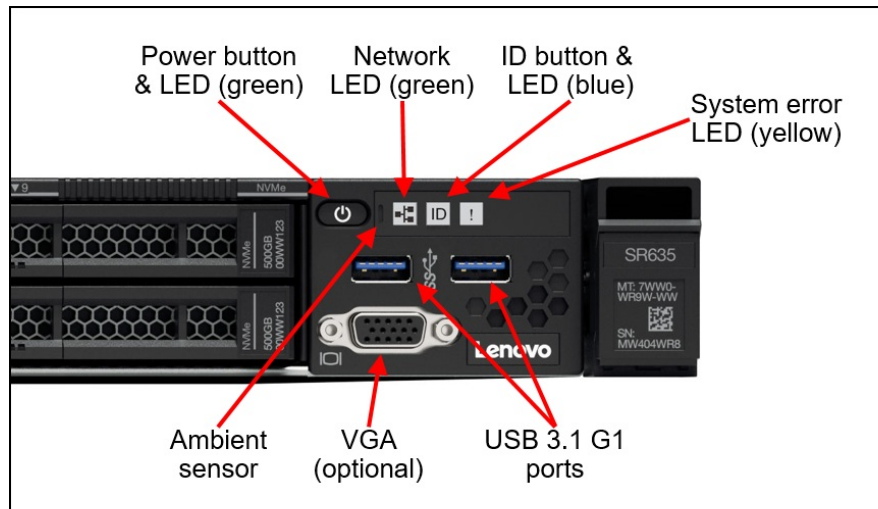

Figure 13. Front operator panel

The server offers light path diagnostics. If an environmental condition exceeds a threshold or if a system component fails, the ASPEED service processor lights LEDs inside the server to help you diagnose the problem and find the failing part. The SR635 has fault LEDs next to the following components:

- Each memory DIMM
- Each drive bay
- Each system fan
- Each power supply

The front of the server also houses an information pull-out tab (also known as the network access tag). See [Figure 2](#) for the location. A label on the tab shows the network information (MAC address and other data) to remotely access the service processor.

Remote management

Remote server management is provided through industry-standard interfaces:

- Intelligent Platform Management Interface (IPMI) Version 2.0
- Simple Network Management Protocol (SNMP) Version 3 (traps and gets)
- Redfish support to the Redfish Schema 2018.1 (DMTF DSP0266 1.5.0 compliant)
- Web browser - HTML 5-based browser interface (Java and ActiveX not required) using a responsive design (content optimized for the device being used - laptop, tablet, phone) with NLS support

Remote connectivity is provided by a dedicated 1Gb Ethernet management port (see the locations of ports at the rear of the server in the [Components and connectors](#) section). Remote management can also be performed via the first port of the installed OCP adapter using the shared management capability of the adapter via NC-SI. NC-SI connectivity is 10/100 Mbps Ethernet.

IPMI via the Ethernet port (IPMI over LAN) is supported, however it is disabled by default. For CTO orders you can specify whether you want the feature enabled or disabled in the factory, using the feature codes listed in the following table.

Table 62. IPMI-over-LAN settings

Part number	Feature code	Description
CTO only	B7XZ	Disable IPMI-over-LAN (default)
CTO only	B7Y0	Enable IPMI-over-LAN

A virtual presence (iKVM remote control and virtual media) capability also comes standard in the server for remote server management.

The remote control functions include the following:

- Remotely viewing video with graphics resolutions up to 1920x1080 at 60 Hz and 32 bits per pixel, regardless of the system state
- Remotely accessing the server using the keyboard and mouse from a remote client
- Full remote administration with seamless access from UEFI POST through to operating system load
- OS independent - no drivers or OS agents required
- Support for up to four remote users simultaneously

The remote media functions include:

- USB 2.0 compliant connectivity
- Up to four simultaneously mounted diskette, HDD, CD, DVD, USB flash drive, or image files
- Optional encryption on connections
- Requires Java Runtime Environment (JRE) 1.4.2 or later
- Can be used as a boot device
- Persistent session across system reset (but not across AC power loss)

Lenovo XClarity Administrator

Lenovo XClarity Administrator is a centralized resource management solution designed to reduce complexity, speed response, and enhance the availability of Lenovo systems and solutions. Lenovo XClarity Administrator provides agent-free hardware management for ThinkSystem servers, in addition to other Lenovo servers. The administration dashboard is based on HTML 5 and allows fast location of resources so tasks can be run quickly.

On the SR635, XClarity Administrator v3.2.0 or later is required for full firmware-update support, managed authentication, and remote control. The baseboard management controller firmware should be v3.56 or later.

Lenovo XClarity Administrator supports the following functions on the SR635:

- Asset management
- Hardware monitoring
- Hardware management
- Configuration management
- Firmware compliance and updates
- Device authentication using an LDAP server
- Remote control
- Warranty status
- Automatic problem notification (call home)

For details of these functions, see the paper *Introduction to Managing ThinkSystem SR635 and SR655 Servers with Lenovo XClarity Administrator*, available from <https://lenovopress.com/lp1419>

The following functions are not supported:

- Network interfaces using IPv6 link-Local Address (LLA) (only IPv4 addresses and global unicast IPv6 address are supported)
- Server configuration other than BIOS configuration using configuration patterns
- Windows OS device driver updates
- Operating system deployment
- Virtually reseating a server
- Single sign-on to the management controller interface

For more information about Lenovo XClarity Administrator, including ordering part numbers, see the Lenovo XClarity Administrator Product Guide: <https://lenovopress.com/tips1200-lenovo-xclarity-administrator>

Lenovo XClarity Provisioning Manager Lite

Lenovo XClarity Provisioning Manager Lite (LXPM Lite) v2 is an embedded application for system setup and firmware upgrades. The tool is accessed during system boot by pressing F11 when prompted.

The software tool provides the following functions:

- Easy-to-use, language-selectable graphical interface
- Integrated help system
- Automatic hardware detection
- Ability to install an operating system and device drivers either in an unattended mode or manually
- Ability to clone the settings in one server to other similarly configured Lenovo servers
- Supports RAID setup
- Diagnostics for memory test, hard disk drive test, and RAID log collection.

The LXPM Lite user interface is shown in the following figure.

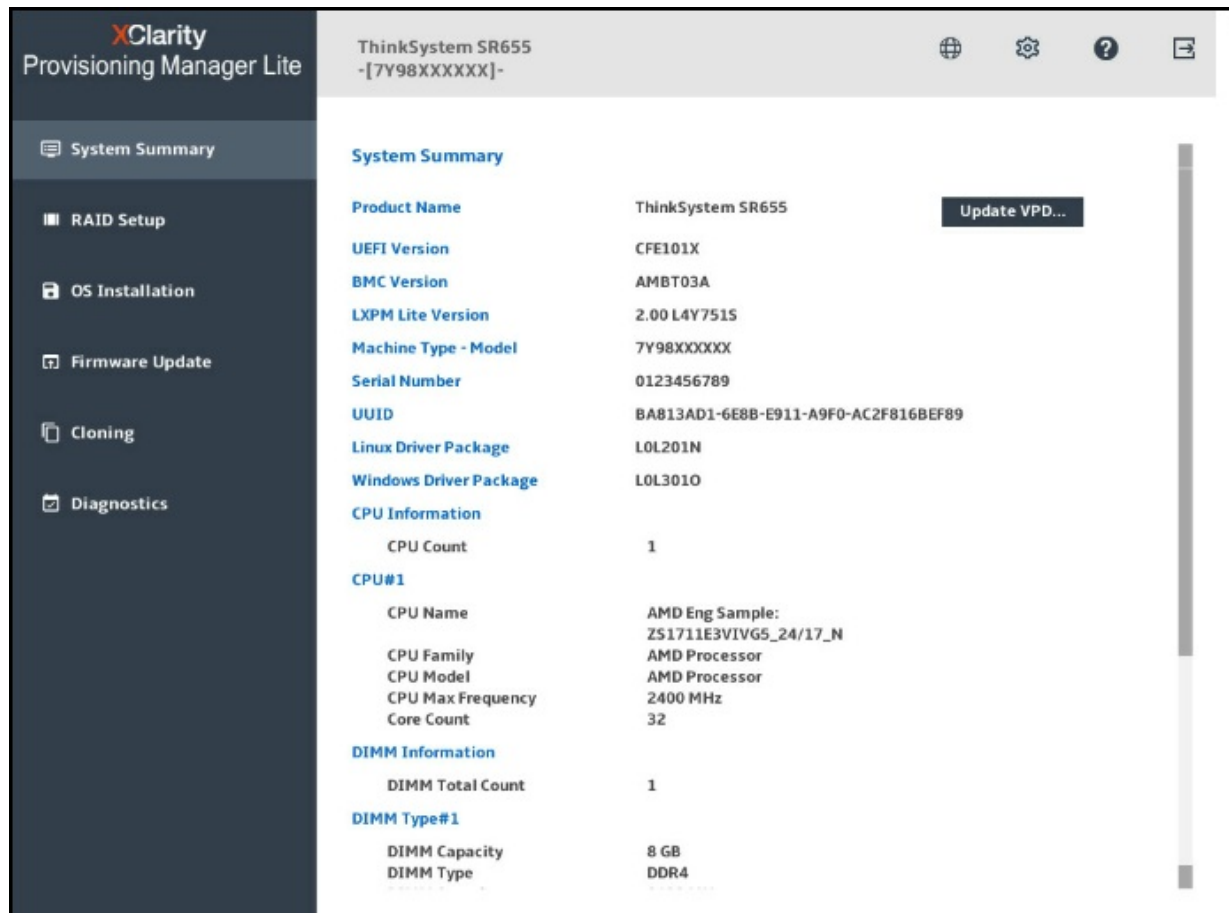

Figure 14. Lenovo XClarity Provisioning Manager Lite user interface (pre-production server)

For more information about LXPM Lite, see the following support page:

<https://datacentersupport.lenovo.com/us/en/solutions/HT507133>

Lenovo XClarity Essentials

Lenovo offers the following XClarity Essentials software tools that can help you set up, use, and maintain the server at no additional cost:

- **Lenovo Essentials OneCLI**

OneCLI is a collection of server management tools that uses a command line interface program to manage firmware, hardware, and drivers. It provides functions to collect full system health information (including health status), configure system settings, update BMC/UEFI firmware (in-band and out-of-band), and update drivers.

Note: OneCLI on the SR635 currently does not support firmware update of adapters. For UEFI settings, all OneCLI commands are supported. For BMC settings, OneCLI support is limited to network, ntp, dns, account commands and the following VPD parameters: VPD.Model, VPD.SerialNumber, VPD.AssetId, VPD.UUID.

- **Lenovo Essentials UpdateXpress**

The UpdateXpress tool is a standalone GUI application for firmware and device driver updates that enables you to maintain your server firmware and device drivers up-to-date and help you avoid unnecessary server outages. The tool acquires and deploys individual updates and UpdateXpress System Packs (UXSPs) which are integration-tested bundles.

Note: UpdateXpress on the SR635 is currently limited to only support BMC and UEFI firmware updates.

- **Lenovo Essentials Bootable Media Creator**

The Bootable Media Creator (BOMC) tool is used to create bootable media for offline firmware update.

For more information and downloads, visit the Lenovo XClarity Essentials web page:

<http://support.lenovo.com/us/en/documents/LNVO-center>

Lenovo XClarity Energy Manager

Lenovo XClarity Energy Manager provides a stand-alone, web-based agent-less power management console that provides real time data and enables you to observe, plan and manage power and cooling for Lenovo servers. Using built-in intelligence, it identifies server power consumption trends and ideal power settings and performs cooling analysis so that you can define and optimize power-saving policies.

Lenovo XClarity Energy Manager offers the following capabilities:

- Monitors room, row, rack, and device levels in the data center
- Reports vital server information, such as power, temperature and resource utilization
- Monitors inlet temperature to locate hot spots, reducing the risk of data or device damage
- Provides finely-grained controls to limit platform power in compliance with IT policy
- Generates alerts when a user-defined threshold is reached

Note: In the SR635, system power capping function is not supported on Lenovo XClarity Energy Manager.

Lenovo XClarity Energy Manager is an optional software component that is licensed on a per managed node basis, that is, each managed server requires a license. To manage systems, a node license pack should be purchased. The following table lists the geo-specific Lenovo XClarity Energy Manager software license options.

Table 63. Lenovo XClarity Energy Manager software options

Description	Part number (NA, AP, Japan)*	Part number (EMEA, LA)**	Quantity
Lenovo XClarity Energy Manager, 1 Node w/ 1 Yr S&S	01DA225	01DA228	1

For more information, refer to the Lenovo XClarity Energy Manager web page:
<http://datacentersupport.lenovo.com/us/en/solutions/invo-ixem>

Lenovo Capacity Planner is a power consumption evaluation tool that enhances data center planning by enabling IT administrators and pre-sales professionals to understand various power characteristics of racks, servers, and other devices. Capacity Planner can dynamically calculate the power consumption, current, British Thermal Unit (BTU), and volt-ampere (VA) rating at the rack level, improving the planning efficiency for large scale deployments.

For more information, refer to the Capacity Planner web page:
<http://datacentersupport.lenovo.com/us/en/solutions/invo-lcp>

Security

The SR635 server offers the following security features:

- Administrator and power-on password
- Integrated Trusted Platform Module (TPM) supporting TPM 2.0
- Optional Nationz TPM 2.0, available only in China (CTO only)
- Optional chassis intrusion switch (CTO only)
- Optional lockable front security bezel

The server is NIST SP 800-147B compliant.

The optional lockable front security bezel is shown in the following figure and includes a key that enables you to secure the bezel over the drives and system controls thereby reducing the chance of unauthorized or accidental access to the server.

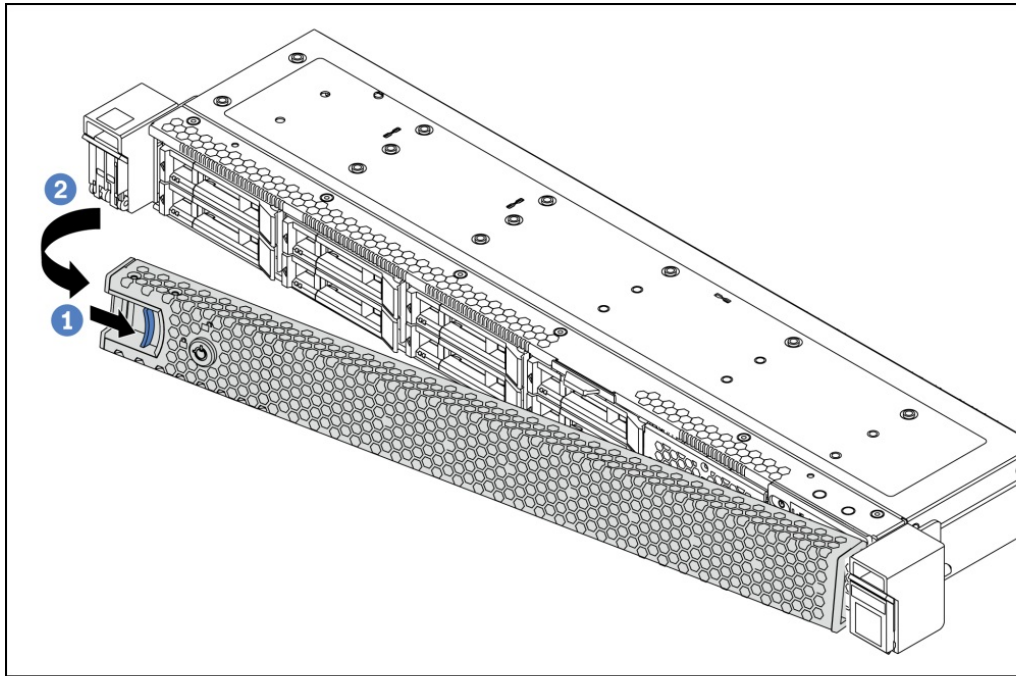

Figure 15. Lockable front security bezel

The dimensions of the security bezel are:

- Width: 437 mm (17.2 in.)
- Height: 43 mm (1.3 in.)
- Width: 23 mm (0.9 in.)

The following table lists the security options for the SR635.

Table 64. Security features

Part number	Feature code	Description
None*	B22N	ThinkSystem Nationz Trusted Platform Module v2.0 (China customers only)
None*	B9V3	ThinkSystem Intrusion Switch Cable
7Z17A02581	AUWR	ThinkSystem 1U Security Bezel

* Not available as a field upgrade. The component is CTO or on pre-configured models only.

GPU support with the intrusion switch: If the intrusion switch is selected, then a GPU cannot be installed in slot 1.

Rack installation

The following table lists the rack installation options that are available for the server.

The VGA Upgrade Kit allows you to upgrade your server by adding a VGA video port to the front of the server (if the server does not already come with a front VGA port). When the front VGA is in use, the rear VGA port is automatically disabled.

Table 65. Rack installation options

Option	Feature Code	Description
Optional front VGA port		
4XH7A80465	BMNW or BMNX*	ThinkSystem SR635 Front VGA Upgrade Kit v2 (adds a VGA port to the front of the server)
4XH7A09849	AUWU or B5TX*	ThinkSystem SR635 Front VGA Upgrade Kit (adds a VGA port to the front of the server)
4-post rail kits		
4M17A13564	BK7W	ThinkSystem Toolless Friction Rail v2
7M27A05702	AXCA	ThinkSystem Toolless Slide Rail
7M27A05701	AXCB	ThinkSystem Toolless Slide Rail Kit with 1U CMA
Cable management arm		
7M27A05699	B136	ThinkSystem 1U CMA Upgrade Kit for Toolless Slide Rail

* BMNX / B5TX is a 950mm cable for configurations with 3.5-inch drive bays in the front of the server; BMNW / AUWU is a 715mm cable for configurations with 2.5-inch drive bays in the front of the server. The related option part number contains both cables.

The following table summarizes the rail kit features and specifications.

Table 66. Rail kit features and specifications summary

Feature	ThinkSystem Toolless Slide Rail	ThinkSystem Toolless Friction Rail v2
Part number	7M27A05702 (optional CMA) 7M27A05701 (with CMA)	4M17A13564
Rail type	Full-out slide (ball bearing)	Half-out slide (friction)
Toolless installation	Yes	Yes
Cable Management Arm (CMA) support	Yes <ul style="list-style-type: none"> Standard on 7M27A05701 For 7M27A05702, use 7M27A05699 	No
In-rack server maintenance	Yes	No
1U PDU support	Yes	Yes
0U PDU support	Limited*	Limited**
Rack type	Lenovo and IBM 4-post, IEC standard-compliant	Lenovo and IBM 4-post, IEC standard-compliant
Mounting holes	Square or round	Square or round
Mounting flange thickness	2 mm - 3.3 mm (0.08 - 0.13 in.)	2 mm - 3.3 mm (0.08 - 0.13 in.)
Distance between front and rear mounting flanges	610 mm - 864 mm (24 - 34 in.)	610 mm - 864 mm (24 - 34 in.)
Rail length***	730 mm (28.74 in.)	751 mm (29.6 in.)

* For 0U PDU support, the rack must be at least 1100 mm (43.31 in.) deep without a CMA, or at least 1200 mm (47.24 in.) deep if a CMA is used.

** For 0U PDU support with the friction rail kit, the rack must be at least 1000 mm (39.37 in.) deep.

*** Measured when mounted on the rack, from the front surface of the front mounting flange to the rear most point of the rail.

Rack shipment: The following restriction applies when shipping the SR635 in a rack:

- No 2.5-inch rear drive bays

Operating system support

The SR635 with EPYC 7003 processors supports the following operating systems:

- Microsoft Windows Server 2016
- Microsoft Windows Server 2019
- Microsoft Windows Server 2022
- Red Hat Enterprise Linux 8.3
- Red Hat Enterprise Linux 8.4
- Red Hat Enterprise Linux 8.5
- Red Hat Enterprise Linux 8.6
- Red Hat Enterprise Linux 8.7
- Red Hat Enterprise Linux 8.8
- Red Hat Enterprise Linux 9.0
- Red Hat Enterprise Linux 9.1
- Red Hat Enterprise Linux 9.2
- SUSE Linux Enterprise Server 12 SP5
- SUSE Linux Enterprise Server 12 Xen SP5
- SUSE Linux Enterprise Server 15 SP2
- SUSE Linux Enterprise Server 15 SP3
- SUSE Linux Enterprise Server 15 SP4
- SUSE Linux Enterprise Server 15 Xen SP2
- SUSE Linux Enterprise Server 15 Xen SP3
- SUSE Linux Enterprise Server 15 Xen SP4
- Ubuntu 22.04 LTS 64-bit
- VMware ESXi 6.7 U3
- VMware ESXi 7.0 U2
- VMware ESXi 7.0 U3
- VMware ESXi 8.0
- VMware ESXi 8.0 U1

The SR635 with EPYC 7002 processors supports the following operating systems:

- Microsoft Windows Server 2016
- Microsoft Windows Server 2019
- Microsoft Windows Server 2022
- Red Hat Enterprise Linux 7.6
- Red Hat Enterprise Linux 7.7
- Red Hat Enterprise Linux 7.8
- Red Hat Enterprise Linux 7.9
- Red Hat Enterprise Linux 8.0
- Red Hat Enterprise Linux 8.1
- Red Hat Enterprise Linux 8.2
- Red Hat Enterprise Linux 8.3
- Red Hat Enterprise Linux 8.4
- Red Hat Enterprise Linux 8.5
- Red Hat Enterprise Linux 8.6
- Red Hat Enterprise Linux 8.7
- Red Hat Enterprise Linux 8.8
- Red Hat Enterprise Linux 9.0
- Red Hat Enterprise Linux 9.1
- Red Hat Enterprise Linux 9.2
- SUSE Linux Enterprise Server 12 SP4

- SUSE Linux Enterprise Server 12 SP5
- SUSE Linux Enterprise Server 12 Xen SP4
- SUSE Linux Enterprise Server 12 Xen SP5
- SUSE Linux Enterprise Server 15 SP1
- SUSE Linux Enterprise Server 15 SP2
- SUSE Linux Enterprise Server 15 SP3
- SUSE Linux Enterprise Server 15 SP4
- SUSE Linux Enterprise Server 15 Xen SP1
- SUSE Linux Enterprise Server 15 Xen SP2
- SUSE Linux Enterprise Server 15 Xen SP3
- SUSE Linux Enterprise Server 15 Xen SP4
- Ubuntu 22.04 LTS 64-bit
- VMware ESXi 6.5 U3
- VMware ESXi 6.7 U3
- VMware ESXi 7.0
- VMware ESXi 7.0 U1
- VMware ESXi 7.0 U2
- VMware ESXi 7.0 U3
- VMware ESXi 8.0
- VMware ESXi 8.0 U1

For a complete list of supported, certified and tested operating systems, plus additional details and links to relevant web sites, see the Operating System Interoperability Guide:

- SR635 with EPYC 7003: <https://lenovopress.com/osig#servers=sr635-7y98-7y99-epyc-7003>
- SR635 with EPYC 7002: <https://lenovopress.com/osig#servers=sr635-7y98-7y99-epyc-7002>

For configure-to-order configurations, the server can be preloaded with VMware ESXi installed on M.2 cards. Ordering information is listed in the following table.

Table 67. VMware ESXi preload

Part number	Feature code	Description
CTO only	B6U0	VMware ESXi 6.5 U3 (factory installed) (EPYC 7002 only)
CTO only	B88T	VMware ESXi 6.7 U3 (factory installed)
CTO only	BBZG	VMware ESXi 7.0 (Factory Installed) (EPYC 7002 only)
CTO only	BE5E	VMware ESXi 7.0 U1 (Factory Installed) (EPYC 7002 only)
CTO only	BHSR	VMware ESXi 7.0 U2 (Factory Installed)
CTO only	BMEY	VMware ESXi 7.0 U3 (Factory Installed)
CTO only	BMT5	VMware ESXi 8.0 (Factory Installed)
CTO only	BQ8S	VMware ESXi 8.0 U1 (Factory Installed)

Physical and electrical specifications

The SR635 has the following overall physical dimensions, excluding components that extend outside the standard chassis, such as EIA flanges, front security bezel (if any), and power supply handles:

- Width: 440 mm (17.3 inches)
- Height: 43 mm (1.7 inches)
- Depth: 755 mm (29.7 inches)

The following table lists the detailed dimensions. See the figure below for the definition of each dimension.

Table 68. Detailed dimensions

Dimension	Description
482 mm	X_a = Width, to the outsides of the front EIA flanges
435 mm	X_b = Width, to the rack rail mating surfaces
440 mm	X_c = Width, to the outer most chassis body feature
43 mm	Y_a = Height, from the bottom of chassis to the top of the chassis
714 mm	Z_a = Depth, from the rack flange mating surface to the rearmost I/O port surface
721 mm	Z_b = Depth, from the rack flange mating surface to the rearmost feature of the chassis body
743 mm	Z_c = Depth, from the rack flange mating surface to the rearmost feature such as power supply handle
35 mm	Z_d = Depth, from the forwardmost feature on front of EIA flange to the rack flange mating surface
47 mm	Z_e = Depth, from the front of security bezel (if applicable) or forwardmost feature to the rack flange mating surface

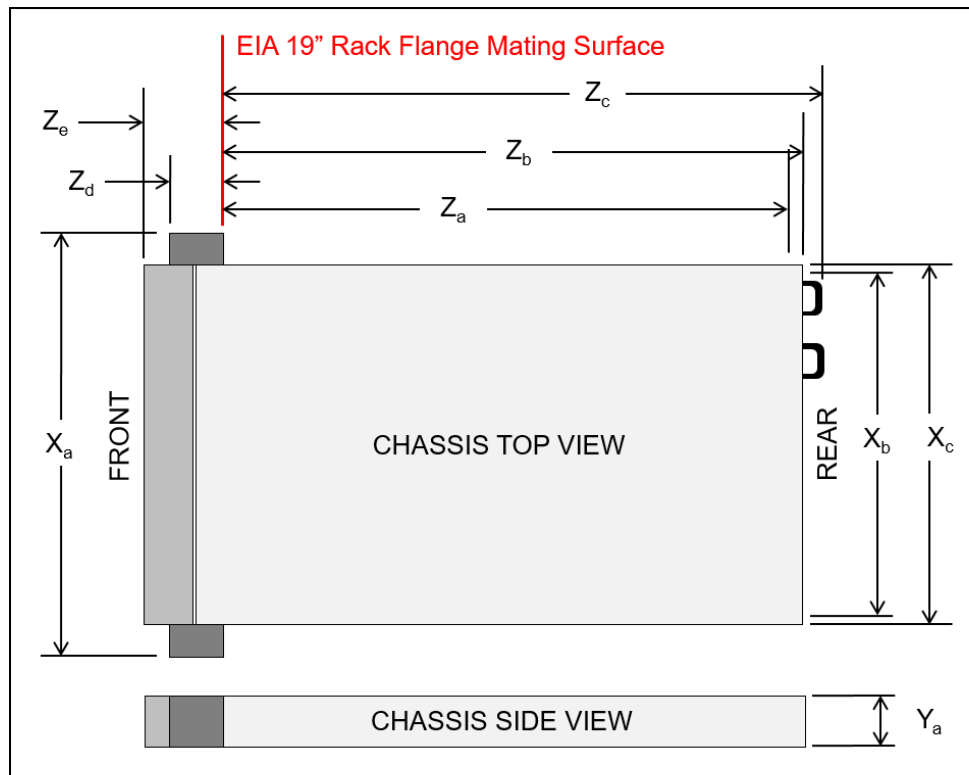

Figure 16. Server dimensions

The shipping dimensions (cardboard packaging) of the SR635 are as follows:

- Width: 587 mm (23.1 inches)
- Height: 225 mm (8.9 inches)
- Depth: 998 mm (39.3 inches)

The server has the following weight:

- Maximum weight: 19.2 kg (42.3 lb)

Electrical specifications for AC power supplies:

- Electrical - Input voltage

- 100 - 127 (nominal) V AC, 50 Hz or 60 Hz
- 200 - 240 (nominal) V AC, 50 Hz or 60 Hz
- 180 - 300 V DC (China only)
- Inlet current:
 - 100-127 V:
 - 550W power supply: 6.2 A
 - 750W power supply: 8.4 A
 - 1100W power supply: 12 A
 - 200-240 V:
 - 550W power supply: 3.0 A
 - 750W power supply: 4.1 A
 - 1100W power supply: 6 A

Electrical specifications for DC input power supply:

- Input voltage: -48 to -60 Vdc
- Inlet current (1100W power supply): 26 A

Operating environment

The ThinkSystem SR635 server complies with ASHRAE Class A2 specifications with most configurations, and depending on the hardware configuration, also complies with ASHRAE Class A3 and Class A4 specifications. System performance may be impacted when operating temperature is outside ASHRAE A2 specification.

The restrictions to ASHRAE A2 support are as follows:

- The use of a processor with a TDP of 225W or higher requires the ambient temperature be no more than 30°C
- The use of Two GPUs and a processor with a TDP higher than 120W requires the ambient temperature be no more than 30°C
- The use of Three GPUs requires the ambient temperature be no more than 30°C
- The use of Mid drive bays requires the ambient temperature be no more than 30°C
- The use of Rear drive bays requires the ambient temperature be no more than 30°C
- The use of Ethernet/InfiniBand adapters of 100Gb or 200Gb, combined with the use of a processor with a TDP of 180W or higher, requires the ambient temperature be no more than 30°C

To comply with ASHRAE class A3 and class A4 specifications, the server models must meet the following hardware configuration requirements:

- Processor TDP greater than 155W not supported
- No support for 10x 2.5" front drive bays (the 4x 3.5-inch and 8x 2.5-inch bay configurations are supported)
- No support for NVMe drives
- No support for rear drive bays or mid drive bays
- No support for GPUs
- No support for M.2
- No support for PCIe flash storage adapters
- No support for OCP networking adapters of 10GbE or faster
- No support for Ethernet adapters of 10GbE or faster
- No support for DIMMs of 128GB or larger capacity
- Advanced heatsink (feature B5UR) and performance fans (feature B5X0) must be configured

Temperature and humidity

The server is supported in the following environment:

- Air temperature:
 - Operating:
 - ASHRAE Class A2: 10°C to 35°C (50°F to 95°F); the maximum ambient temperature decreases by 1°C for every 300 m (984 ft) increase in altitude above 900 m (2,953 ft).
 - ASHRAE Class A3: 5°C to 40°C (41°F to 104°F); the maximum ambient temperature decreases by 1°C for every 175 m (574 ft) increase in altitude above 900 m (2,953 ft).
 - ASHRAE Class A4: 5°C to 45°C (41°F to 113°F); the maximum ambient temperature decreases by 1°C for every 125 m (410 ft) increase in altitude above 900 m (2,953 ft).
 - Server off: 5°C to 45°C (41°F to 113°F)
 - Shipment/storage: -40°C to 60°C (-40°F to 140°F)
- Maximum altitude: 3,050 m (10,000 ft)
- Relative Humidity (non-condensing):
 - Operating
 - ASHRAE Class A2: 8% to 80%; maximum dew point: 21°C (70°F)
 - ASHRAE Class A3: 8% to 85%; maximum dew point: 24°C (75°F)
 - ASHRAE Class A4: 8% to 90%; maximum dew point: 24°C (75°F)
 - Shipment/storage: 8% to 90%

Heat output

The server generates the following heat:

- Heat/thermal output:
 - Minimum configuration: 346 BTU/hr, 101 W
 - Maximum configuration: 3197 BTU/hr, 937 W

Acoustical noise emissions

The server has the following acoustic noise emissions declaration:

- Sound power level (L_{WAd}):
 - Idling: 5.7 Bel (typical), 7.0 Bel (Storage rich), 7.0 Bel (GPU rich)
 - Operating: 5.9 Bel (typical), 7.2 Bel (storage rich), 8.5 Bel (GPU rich)
- Sound pressure level (L_{pAm}):
 - Idling: 41 dBA (Typical), 54 dBA (Storage rich), 54 dBA (GPU rich)
 - Operating: 43 dBA (Typical), 56 dBA (Storage rich), 69 dBA (GPU rich)

Notes:

- The sound levels were measured in controlled acoustical environments according to procedures specified by ISO7779 and are reported in accordance with ISO 9296.
- The declared acoustic sound levels are based on the following configurations, which may change slightly depending on configuration/conditions :
 - Typical: 1x 155W CPU, 8x 32GB RDIMM, 8x 2.5" HDD, 530-8i RAID, X710-T2L OCP, 2x 750W PSU
 - Storage rich: 1x 155W CPU, 16x 64GB RDIMM, 16x NVMe, 10GBASE-T 4-port PCIe Ethernet Adapter, 2x 750W PSU
 - GPU rich: 1x 155W CPU, 16x 64GB RDIMM, 10x 2.5" HDD, 930-16i RAID, 10GBASE-T 4-port PCIe Ethernet Adapter, 2x T4 GPU, 2x 1100W PSU

Shock and vibration

The server has the following vibration and shock limits:

- Vibration:
 - Operating: 0.21 G rms at 5 Hz to 500 Hz for 15 minutes across 3 axes
 - Non-operating: 1.04 G rms at 2 Hz to 200 Hz for 15 minutes across 6 surfaces
- Shock:
 - Operating: 15 G for 3 milliseconds in each direction (positive and negative X, Y, and Z axes)
 - Non-operating:
 - 12 kg - 22 kg: 50 G for 152 in./sec velocity change across 6 surfaces

Particulate contamination

Airborne particulates (including metal flakes or particles) and reactive gases acting alone or in combination with other environmental factors such as humidity or temperature might damage the system that might cause the system to malfunction or stop working altogether.

The following specifications indicate the limits of particulates that the system can tolerate:

- Reactive gases:
 - The reactivity rate of copper coupons shall be less than 200 Angstroms per month (Å/month)
 - The reactivity rate of silver coupons shall be less than 200 Å/month
- Airborne particulates:
 - The room air should be continuously filtered with MERV 8 filters.
 - Air entering a data center should be filtered with MERV 11 or preferably MERV 13 filters.
 - The deliquescent relative humidity of the particulate contamination should be more than 60% RH
 - Data centers must be free of zinc whiskers

For additional information, see the Specifications section of the Setup Guide for the server, available from the Lenovo Documents site, <https://pubs.lenovo.com/>

Warranty and Support

The SR635 has a 1-year or 3-year warranty based on the machine type of the system:

- 7Y98 - 1 year warranty
- 7Y99 - 3 year warranty

The standard warranty terms are customer-replaceable unit (CRU) and onsite (for field-replaceable units FRUs only) with standard call center support during normal business hours and 9x5 Next Business Day Parts Delivered.

Lenovo's additional support services provide a sophisticated, unified support structure for your data center, with an experience consistently ranked number one in customer satisfaction worldwide. Available offerings include:

- **Premier Support**

Premier Support provides a Lenovo-owned customer experience and delivers direct access to technicians skilled in hardware, software, and advanced troubleshooting, in addition to the following:

- Direct technician-to-technician access through a dedicated phone line
- 24x7x365 remote support
- Single point of contact service
- End to end case management
- Third-party collaborative software support
- Online case tools and live chat support
- On-demand remote system analysis

- **Warranty Upgrade (Preconfigured Support)**

Services are available to meet the on-site response time targets that match the criticality of your systems.

- 3, 4, or 5 years of service coverage
- 1-year or 2-year post-warranty extensions
- **Foundation Service:** 9x5 service coverage with next business day onsite response. YourDrive YourData is an optional extra (see below).
- **Essential Service:** 24x7 service coverage with 4-hour onsite response or 24-hour committed repair (available only in select markets). Bundled with YourDrive YourData.
- **Advanced Service:** 24x7 service coverage with 2-hour onsite response or 6-hour committed repair (available only in select markets). Bundled with YourDrive YourData.

- **Managed Services**

Lenovo Managed Services provides continuous 24x7 remote monitoring (plus 24x7 call center availability) and proactive management of your data center using state-of-the-art tools, systems, and practices by a team of highly skilled and experienced Lenovo services professionals.

Quarterly reviews check error logs, verify firmware & OS device driver levels, and software as needed. We'll also maintain records of latest patches, critical updates, and firmware levels, to ensure you systems are providing business value through optimized performance.

- **Technical Account Management (TAM)**

A Lenovo Technical Account Manager helps you optimize the operation of your data center based on a deep understanding of your business. You gain direct access to your Lenovo TAM, who serves as your single point of contact to expedite service requests, provide status updates, and furnish reports to track incidents over time. In addition, your TAM will help proactively make service recommendations and manage your service relationship with Lenovo to make certain your needs are met.

- **Enterprise Server Software Support**

Enterprise Software Support is an additional support service providing customers with software support on Microsoft, Red Hat, SUSE, and VMware applications and systems. Around the clock availability for critical problems plus unlimited calls and incidents helps customers address challenges fast, without incremental costs. Support staff can answer troubleshooting and diagnostic questions, address product comparability and interoperability issues, isolate causes of problems, report defects to software vendors, and more.

- **YourDrive YourData**

Lenovo's YourDrive YourData is a multi-drive retention offering that ensures your data is always under your control, regardless of the number of drives that are installed in your Lenovo server. In the unlikely event of a drive failure, you retain possession of your drive while Lenovo replaces the failed drive part. Your data stays safely on your premises, in your hands. The YourDrive YourData service can be purchased in convenient bundles and is optional with Foundation Service. It is bundled with Essential Service and Advanced Service.

- **Health Check**

Having a trusted partner who can perform regular and detailed health checks is central to maintaining efficiency and ensuring that your systems and business are always running at their best. Health Check supports Lenovo-branded server, storage, and networking devices, as well as select Lenovo-supported products from other vendors that are sold by Lenovo or a Lenovo-Authorized Reseller.

Examples of region-specific warranty terms are second or longer business day parts delivery or parts-only base warranty.

If warranty terms and conditions include onsite labor for repair or replacement of parts, Lenovo will dispatch a service technician to the customer site to perform the replacement. Onsite labor under base warranty is limited to labor for replacement of parts that have been determined to be field-replaceable units (FRUs). Parts that are determined to be customer-replaceable units (CRUs) do not include onsite labor under base warranty.

If warranty terms include parts-only base warranty, Lenovo is responsible for delivering only replacement parts that are under base warranty (including FRUs) that will be sent to a requested location for self-service. Parts-only service does not include a service technician being dispatched onsite. Parts must be changed at customer's own cost and labor and defective parts must be returned following the instructions supplied with the spare parts.

Lenovo Service offerings are region-specific. Not all preconfigured support and upgrade options are available in every region. For information about Lenovo service upgrade offerings that are available in your region, refer to the following resources:

- Service part numbers in Lenovo Data Center Solution Configurator (DCSC):
<http://dcsc.lenovo.com/#/services>
- Lenovo Services Availability Locator
<http://lenovolocator.com/>

For service definitions, region-specific details, and service limitations, please refer to the following documents:

- Lenovo Statement of Limited Warranty for Infrastructure Solutions Group (ISG) Servers and System Storage
<http://pcsupport.lenovo.com/us/en/solutions/ht503310>
- Lenovo Data Center Services Agreement
<http://support.lenovo.com/us/en/solutions/ht116628>

Services

Lenovo Services is a dedicated partner to your success. Our goal is to reduce your capital outlays, mitigate your IT risks, and accelerate your time to productivity.

Note: Some service options may not be available in all markets or regions. For more information, go to <https://www.lenovo.com/services>. For information about Lenovo service upgrade offerings that are available in your region, contact your local Lenovo sales representative or business partner.

Here's a more in-depth look at what we can do for you:

- **Asset Recovery Services**

Asset Recovery Services (ARS) helps customers recover the maximum value from their end-of-life equipment in a cost-effective and secure way. On top of simplifying the transition from old to new equipment, ARS mitigates environmental and data security risks associated with data center equipment disposal. Lenovo ARS is a cash-back solution for equipment based on its remaining market value, yielding maximum value from aging assets and lowering total cost of ownership for your customers. For more information, see the ARS page, <https://lenovopress.com/lp1266-reduce-e-waste-and-grow-your-bottom-line-with-lenovo-ars>.

- **Assessment Services**

An Assessment helps solve your IT challenges through an onsite, multi-day session with a Lenovo technology expert. We perform a tools-based assessment which provides a comprehensive and thorough review of a company's environment and technology systems. In addition to the technology based functional requirements, the consultant also discusses and records the non-functional business requirements, challenges, and constraints. Assessments help organizations like yours, no matter how large or small, get a better return on your IT investment and overcome challenges in the ever-changing technology landscape.

- **Design Services**

Professional Services consultants perform infrastructure design and implementation planning to support your strategy. The high-level architectures provided by the assessment service are turned into low level designs and wiring diagrams, which are reviewed and approved prior to implementation. The implementation plan will demonstrate an outcome-based proposal to provide business capabilities through infrastructure with a risk-mitigated project plan.

- **Basic Hardware Installation**

Lenovo experts can seamlessly manage the physical installation of your server, storage, or networking hardware. Working at a time convenient for you (business hours or off shift), the technician will unpack and inspect the systems on your site, install options, mount in a rack cabinet, connect to power and network, check and update firmware to the latest levels, verify operation, and dispose of the packaging, allowing your team to focus on other priorities.

- **Deployment Services**

When investing in new IT infrastructures, you need to ensure your business will see quick time to value with little to no disruption. Lenovo deployments are designed by development and engineering teams who know our Products & Solutions better than anyone else, and our technicians own the process from delivery to completion. Lenovo will conduct remote preparation and planning, configure & integrate systems, validate systems, verify and update appliance firmware, train on administrative tasks, and provide post-deployment documentation. Customer's IT teams leverage our skills to enable IT staff to transform with higher level roles and tasks.

- **Integration, Migration, and Expansion Services**

Move existing physical & virtual workloads easily, or determine technical requirements to support increased workloads while maximizing performance. Includes tuning, validation, and documenting ongoing run processes. Leverage migration assessment planning documents to perform necessary migrations.

Regulatory compliance

The SR635 server conforms to the following standards:

- Energy Star 3.0
- FCC: Verified to comply with Part 15 of the FCC Rules, Class A
- Canada ICES-003, issue 6, Class A
- UL/IEC 60950-1
- CSA C22.2 No. 60950-1
- NOM-019
- Argentina IEC60950-1
- Japan VCCI, Class A
- Australia/New Zealand AS/NZS CISPR 32, Class A; AS/NZS 60950.1
- IEC 60950-1 (CB Certificate and CB Test Report)
- China CCC (GB4943.1), GB9254 Class A, GB17625.1
- Taiwan BSMI CNS13438, Class A; CNS14336-1
- Korea KN32, Class A; KN35
- Russia, Belorussia and Kazakhstan, EAC: TP TC 004/2011(for Safety); TP TC 020/2011(for EMC)
- CE Mark (EN55032 Class A, EN60950-1, EN55024, EN61000-3-2, and EN61000-3-3)
- CISPR 32, Class A
- TUV-GS (EN60950-1 /IEC60950-1, EK1-ITB2000)
- India BIS certification

External drive enclosures

The server supports attachment to external drive enclosures using a RAID controller with external ports or a SAS host bus adapter. Adapters supported by the server are listed in the [SAS adapters for external storage](#) section.

Note: Information provided in this section is for ordering reference purposes only. For the operating system and adapter support details, refer to the interoperability matrix for a particular storage enclosure that can be found on the Lenovo Data Center Support web site:

<http://datacentersupport.lenovo.com>

Table 69. External drive enclosures

Model	Description
4587HC1	Lenovo Storage D1212 Disk Expansion Enclosure (2U enclosure wth 12x LFF drive bays)
4587HC2	Lenovo Storage D1224 Disk Expansion Enclosure (2U enclosure wth 24x SFF drive bays)
6413HC1	Lenovo Storage D3284 High Density Expansion Enclosure (5U enclosure wth 84x LFF drive bays)
7DAHCTO1WW	Lenovo ThinkSystem D4390 Direct Attached Storage (4U enclosure wth 90x LFF drive bays)

For details about supported drives, adapters, and cables, see the following Lenovo Press Product Guides:

- Lenovo Storage D1212 and D1224
<http://lenovopress.lenovo.com/lp0512>
- Lenovo Storage D3284
<http://lenovopress.lenovo.com/lp0513>
- Lenovo ThinkSystem D4390
<https://lenovopress.lenovo.com/lp1681>

External storage systems

Lenovo offers the ThinkSystem DE Series and ThinkSystem DM Series external storage systems for high-performance storage. See the DE Series and DM Series product guides for specific controller models, expansion enclosures and configuration options:

- ThinkSystem DE Series Storage
<https://lenovopress.com/storage/thinksystem/de-series#rt=product-guide>
- ThinkSystem DM Series Storage
<https://lenovopress.com/storage/thinksystem/dm-series#rt=product-guide>

External backup units

The server supports both USB-attached RDX backup units and SAS-attached tape drives.

The following table lists the available external SAS tape backup options.

Tip: Verify the end-to-end support of an IBM tape backup solution through the IBM System Storage Interoperation Center (SSIC): <http://www.ibm.com/systems/support/storage/ssic>

Table 70. External SAS backup options

Part number	Description
External SAS tape backup drives	
6160S7E	IBM TS2270 Tape Drive Model H7S
6160S8E	IBM TS2280 Tape Drive Model H8S
6160S9E	IBM TS2290 Tape Drive Model H9S
External SAS tape backup autoloaders	
6171S7R	IBM TS2900 Tape Autoloader w/LTO7 HH SAS
6171S8R	IBM TS2900 Tape Autoloader w/LTO8 HH SAS
6171S9R	IBM TS2900 Tape Autoloader w/LTO9 HH SAS
External tape backup libraries	
6741A1F	IBM TS4300 3U Tape Library-Base Unit
SAS backup drives for TS4300 Tape Library	
01KP937	LTO 7 HH SAS Drive
01KP953	LTO 8 HH SAS Drive
02JH836	LTO 9 HH SAS Drive

For more information, see the list of Product Guides in the Backup units category:
<https://lenovopress.com/servers/options/backup>

The following table lists the external RDX backup options available.

Table 71. External RDX dock and cartridges

Part number	Feature code	Description
External RDX docks		
4T27A10725	B32R	ThinkSystem RDX External USB 3.0 Dock (No cartridge included with the drive)
Cartridges		
7TP7A01601	AVF8	ThinkSystem RDX 500GB Cartridge
7TP7A01602	AVF1	ThinkSystem RDX 1TB Cartridge
7TP7A01603	AVF0	ThinkSystem RDX 2TB Cartridge
7TP7A04318	AXD1	ThinkSystem RDX 4TB Cartridge

For more information, see the Lenovo RDX USB 3.0 Disk Backup Solution product guide:
<https://lenovopress.com/tips0894-rdx-usb-30>

Fibre Channel SAN switches

Lenovo offers the ThinkSystem DB Series of Fibre Channel SAN switches for high-performance storage expansion. See the DB Series product guides for models and configuration options:

- ThinkSystem DB Series SAN Switches:
<https://lenovopress.com/storage/switches/rack#rt=product-guide>

Uninterruptible power supply units

The following table lists the uninterruptible power supply (UPS) units that are offered by Lenovo.

Table 72. Uninterruptible power supply units

Part number	Description
55941AX	RT1.5kVA 2U Rack or Tower UPS (100-125VAC)
55941KX	RT1.5kVA 2U Rack or Tower UPS (200-240VAC)
55942AX	RT2.2kVA 2U Rack or Tower UPS (100-125VAC)
55942KX	RT2.2kVA 2U Rack or Tower UPS (200-240VAC)
55943AX	RT3kVA 2U Rack or Tower UPS (100-125VAC)
55943KX	RT3kVA 2U Rack or Tower UPS (200-240VAC)
55945KX	RT5kVA 3U Rack or Tower UPS (200-240VAC)
55946KX	RT6kVA 3U Rack or Tower UPS (200-240VAC)
55948KX	RT8kVA 6U Rack or Tower UPS (200-240VAC)
55949KX	RT11kVA 6U Rack or Tower UPS (200-240VAC)
55948PX	RT8kVA 6U 3:1 Phase Rack or Tower UPS (380-415VAC)
55949PX	RT11kVA 6U 3:1 Phase Rack or Tower UPS (380-415VAC)
55943KT†	ThinkSystem RT3kVA 2U Standard UPS (200-230VAC) (2x C13 10A, 2x GB 10A, 1x C19 16A outlets)
55943LT†	ThinkSystem RT3kVA 2U Long Backup UPS (200-230VAC) (2x C13 10A, 2x GB 10A, 1x C19 16A outlets)
55946KT†	ThinkSystem RT6kVA 5U UPS (200-230VAC) (2x C13 10A outlets, 1x Terminal Block output)
5594XKT†	ThinkSystem RT10kVA 5U UPS (200-230VAC) (2x C13 10A outlets, 1x Terminal Block output)

† Only available in China and the Asia Pacific market.

For more information, see the list of Product Guides in the UPS category:

<https://lenovopress.com/servers/options/ups>

Power distribution units

The following table lists the power distribution units (PDUs) that are offered by Lenovo.

Table 73. Power distribution units

Part number	Feature code	Description	ANZ	ASEAN	Brazil	EET	MEA	RUCIS	WE	HTK	INDIA	JAPAN	LA	NA	PRC
0U Basic PDUs															
00YJ776	ATZY	0U 36 C13/6 C19 24A 1 Phase PDU	N	Y	Y	N	N	N	N	N	N	Y	Y	Y	N
00YJ777	ATZZ	0U 36 C13/6 C19 32A 1 Phase PDU	Y	Y	N	Y	Y	Y	Y	Y	Y	N	N	Y	Y
00YJ778	AU00	0U 21 C13/12 C19 32A 3 Phase PDU	Y	Y	N	Y	Y	Y	Y	Y	Y	N	N	Y	Y
0U Switched and Monitored PDUs															
00YJ783	AU04	0U 12 C13/12 C19 Switched and Monitored 48A 3 Phase PDU	N	N	Y	N	N	N	Y	N	N	Y	Y	Y	N
00YJ781	AU03	0U 20 C13/4 C19 Switched and Monitored 24A 1 Phase PDU	N	N	Y	N	Y	N	Y	N	N	Y	Y	Y	N
00YJ782	AU02	0U 18 C13/6 C19 Switched and Monitored 32A 3 Phase PDU	Y	Y	Y	Y	Y	Y	Y	Y	Y	N	Y	N	Y
00YJ780	AU01	0U 20 C13/4 C19 Switched and Monitored 32A 1 Phase PDU	Y	Y	Y	Y	Y	Y	Y	Y	Y	N	Y	N	Y
1U Switched and Monitored PDUs															
4PU7A81117	BNDV	1U 18 C19/C13 switched and monitored 48A 3P WYE PDU - ETL	N	N	N	N	N	N	N	N	N	N	N	Y	N
4PU7A77467	BLC4	1U 18 C19/C13 Switched and Monitored 80A 3P Delta PDU	N	N	N	N	N	N	N	N	N	Y	N	Y	N
4PU7A77469	BLC6	1U 12 C19/C13 switched and monitored 60A 3P Delta PDU	N	N	N	N	N	N	N	N	N	N	N	Y	N
4PU7A77468	BLC5	1U 12 C19/C13 switched and monitored 32A 3P WYE PDU	Y	Y	Y	Y	Y	Y	Y	Y	Y	N	Y	Y	Y
4PU7A81118	BNDW	1U 18 C19/C13 switched and monitored 48A 3P WYE PDU - CE	Y	Y	Y	Y	Y	Y	Y	Y	Y	N	Y	N	Y
1U Ultra Density Enterprise PDUs (9x IEC 320 C13 + 3x IEC 320 C19 outlets)															
71763NU	6051	Ultra Density Enterprise C19/C13 PDU 60A/208V/3PH	N	N	Y	N	N	N	N	N	N	Y	Y	Y	N
71762NX	6091	Ultra Density Enterprise C19/C13 PDU Module	Y	Y	Y	Y	Y	Y	Y	Y	Y	Y	Y	Y	Y
1U C13 Enterprise PDUs (12x IEC 320 C13 outlets)															
39M2816	6030	DPI C13 Enterprise PDU Plus Module (WW)	Y	Y	Y	Y	Y	Y	Y	Y	Y	Y	Y	Y	Y
39Y8941	6010	DPI C13 Enterprise PDU Module (WW)	Y	Y	Y	Y	Y	Y	Y	Y	Y	Y	Y	Y	Y
1U C19 Enterprise PDUs (6x IEC 320 C19 outlets)															
39Y8948	6060	DPI C19 Enterprise PDU Module (WW)	Y	Y	Y	Y	Y	Y	Y	Y	Y	Y	Y	Y	Y
1U Front-end PDUs (3x IEC 320 C19 outlets)															
39Y8938	6002	DPI Single-phase 30A/120V Front-end PDU (US)	Y	Y	Y	Y	Y	Y	Y	Y	Y	Y	Y	Y	Y
39Y8939	6003	DPI Single-phase 30A/208V Front-end PDU (US)	Y	Y	Y	Y	Y	Y	Y	Y	Y	Y	Y	Y	Y

Part number	Feature code	Description	ANZ	ASEAN	Brazil	EET	MEA	RUCIS	WE	HTK	INDIA	JAPAN	LA	NA	PRC
39Y8934	6005	DPI Single-phase 32A/230V Front-end PDU (International)	Y	Y	Y	Y	Y	Y	Y	Y	Y	Y	Y	Y	Y
39Y8940	6004	DPI Single-phase 60A/208V Front-end PDU (US)	Y	N	Y	Y	Y	Y	Y	N	N	Y	Y	Y	N
39Y8935	6006	DPI Single-phase 63A/230V Front-end PDU (International)	Y	Y	Y	Y	Y	Y	Y	Y	Y	Y	Y	Y	Y
1U NEMA PDUs (6x NEMA 5-15R outlets)															
39Y8905	5900	DPI 100-127V NEMA PDU	Y	Y	Y	Y	Y	Y	Y	Y	Y	Y	Y	Y	Y
Line cords for 1U PDUs that ship without a line cord															
40K9611	6504	4.3m, 32A/380-415V, EPDU/IEC 309 3P+N+G 3ph wye (non-US) Line Cord	Y	Y	Y	Y	Y	Y	Y	Y	Y	Y	Y	Y	Y
40K9612	6502	4.3m, 32A/230V, EPDU to IEC 309 P+N+G (non-US) Line Cord	Y	Y	Y	Y	Y	Y	Y	Y	Y	Y	Y	Y	Y
40K9613	6503	4.3m, 63A/230V, EPDU to IEC 309 P+N+G (non-US) Line Cord	Y	Y	Y	Y	Y	Y	Y	Y	Y	Y	Y	Y	Y
40K9614	6500	4.3m, 30A/208V, EPDU to NEMA L6-30P (US) Line Cord	Y	Y	Y	Y	Y	Y	Y	Y	Y	Y	Y	Y	Y
40K9615	6501	4.3m, 60A/208V, EPDU to IEC 309 2P+G (US) Line Cord	N	N	Y	N	N	N	Y	N	N	Y	Y	Y	N
40K9617	6505	4.3m, 32A/230V, Souriau UTG Female to AS/NZ 3112 (Aus/NZ) Line Cord	Y	Y	Y	Y	Y	Y	Y	Y	Y	Y	Y	Y	Y
40K9618	6506	4.3m, 32A/250V, Souriau UTG Female to KSC 8305 (S. Korea) Line Cord	Y	Y	Y	Y	Y	Y	Y	Y	Y	Y	Y	Y	Y

For more information, see the Lenovo Press documents in the PDU category:
<https://lenovopress.com/servers/options/pdu>

Rack cabinets

The following table lists the supported rack cabinets.

Table 74. Rack cabinets

Part number	Description
93072RX	25U Standard Rack (1000mm)
93072PX	25U Static S2 Standard Rack (1000mm)
7D6DA007WW	ThinkSystem 42U Onyx Primary Heavy Duty Rack Cabinet (1200mm)
7D6DA008WW	ThinkSystem 42U Pearl Primary Heavy Duty Rack Cabinet (1200mm)
93604PX	42U 1200mm Deep Dynamic Rack
93614PX	42U 1200mm Deep Static Rack
93634PX	42U 1100mm Dynamic Rack
93634EX	42U 1100mm Dynamic Expansion Rack
93074RX	42U Standard Rack (1000mm)
7D6EA009WW	ThinkSystem 48U Onyx Primary Heavy Duty Rack Cabinet (1200mm)
7D6EA00AWW	ThinkSystem 48U Pearl Primary Heavy Duty Rack Cabinet (1200mm)

For specifications about these racks, see the Lenovo Rack Cabinet Reference, available from:
<https://lenovopress.com/lp1287-lenovo-rack-cabinet-reference>

For more information, see the list of Product Guides in the Rack cabinets category:
<https://lenovopress.com/servers/options/racks>

KVM console options

The following table lists the supported KVM consoles.

Table 75. KVM console

Part number	Description
4XF7A84188	ThinkSystem 18.5" LCD Console (with English keyboard)

The following table lists the available KVM switches and the options that are supported with them.

Table 77. KVM switches and options

Part number	Description
KVM Console switches	
1754D2X	Global 4x2x32 Console Manager (GCM32)
1754D1X	Global 2x2x16 Console Manager (GCM16)
1754A2X	Local 2x16 Console Manager (LCM16)
1754A1X	Local 1x8 Console Manager (LCM8)
Cables for GCM and LCM Console switches	
46M5383	Virtual Media Conversion Option Gen2 (VCO2)
46M5382	Serial Conversion Option (SCO)

For more information, see the list of Product Guides in the KVM Switches and Consoles category:

<http://lenovopress.com/servers/options/kvm>

Lenovo Financial Services

Lenovo Financial Services reinforces Lenovo's commitment to deliver pioneering products and services that are recognized for their quality, excellence, and trustworthiness. Lenovo Financial Services offers financing solutions and services that complement your technology solution anywhere in the world.

We are dedicated to delivering a positive finance experience for customers like you who want to maximize your purchase power by obtaining the technology you need today, protect against technology obsolescence, and preserve your capital for other uses.

We work with businesses, non-profit organizations, governments and educational institutions to finance their entire technology solution. We focus on making it easy to do business with us. Our highly experienced team of finance professionals operates in a work culture that emphasizes the importance of providing outstanding customer service. Our systems, processes and flexible policies support our goal of providing customers with a positive experience.

We finance your entire solution. Unlike others, we allow you to bundle everything you need from hardware and software to service contracts, installation costs, training fees, and sales tax. If you decide weeks or months later to add to your solution, we can consolidate everything into a single invoice.

Our Premier Client services provide large accounts with special handling services to ensure these complex transactions are serviced properly. As a premier client, you have a dedicated finance specialist who manages your account through its life, from first invoice through asset return or purchase. This specialist develops an in-depth understanding of your invoice and payment requirements. For you, this dedication provides a high-quality, easy, and positive financing experience.

For your region-specific offers, please ask your Lenovo sales representative or your technology provider about the use of Lenovo Financial Services. For more information, see the following Lenovo website:

<https://www.lenovo.com/us/en/landingpage/lenovo-financial-services/>

Related publications and links

For more information, see these resources:

- Lenovo ThinkSystem SR635 product page:
<https://www.lenovo.com/us/en/data-center/servers/racks/ThinkSystem-SR635-Server/p/77XX7SRSR35>
- Interactive 3D Tour of the ThinkSystem SR635:
<https://lenovopress.com/lp1182>
- Lenovo Press video walk-through of the ThinkSystem SR635:
<https://lenovopress.com/lp1184>
- ThinkSystem SR635 drivers and support
<http://datacentersupport.lenovo.com/products/servers/thinksystem/sr635/7y99/downloads>
- Lenovo Hardware Installation & Removal Videos on the SR635:
 - YouTube: <https://www.youtube.com/playlist?list=PLYV5R7hVcs-DTDY1ImplPpJVOzo7dKq14>
 - Youku: http://list.youku.com/albumlist/show/id_52222446.html
- Lenovo ThinkSystem SR635 product publications:
<http://thinksystem.lenovofiles.com/help/index.jsp>
 - Quick Start
 - Rack Installation Guide
 - Setup Guide
 - Hardware Maintenance Manual
 - Messages and Codes Reference
 - Memory Population Reference
- ServerProven hardware compatibility:
<http://www.lenovo.com/us/en/serverproven>

Related product families

Product families related to this document are the following:

- [1-Socket Rack Servers](#)
- [ThinkSystem SR635 Server](#)

Notices

Lenovo may not offer the products, services, or features discussed in this document in all countries. Consult your local Lenovo representative for information on the products and services currently available in your area. Any reference to a Lenovo product, program, or service is not intended to state or imply that only that Lenovo product, program, or service may be used. Any functionally equivalent product, program, or service that does not infringe any Lenovo intellectual property right may be used instead. However, it is the user's responsibility to evaluate and verify the operation of any other product, program, or service. Lenovo may have patents or pending patent applications covering subject matter described in this document. The furnishing of this document does not give you any license to these patents. You can send license inquiries, in writing, to:

Lenovo (United States), Inc.
8001 Development Drive
Morrisville, NC 27560
U.S.A.
Attention: Lenovo Director of Licensing

LENOVO PROVIDES THIS PUBLICATION "AS IS" WITHOUT WARRANTY OF ANY KIND, EITHER EXPRESS OR IMPLIED, INCLUDING, BUT NOT LIMITED TO, THE IMPLIED WARRANTIES OF NON-INFRINGEMENT, MERCHANTABILITY OR FITNESS FOR A PARTICULAR PURPOSE. Some jurisdictions do not allow disclaimer of express or implied warranties in certain transactions, therefore, this statement may not apply to you.

This information could include technical inaccuracies or typographical errors. Changes are periodically made to the information herein; these changes will be incorporated in new editions of the publication. Lenovo may make improvements and/or changes in the product(s) and/or the program(s) described in this publication at any time without notice.

The products described in this document are not intended for use in implantation or other life support applications where malfunction may result in injury or death to persons. The information contained in this document does not affect or change Lenovo product specifications or warranties. Nothing in this document shall operate as an express or implied license or indemnity under the intellectual property rights of Lenovo or third parties. All information contained in this document was obtained in specific environments and is presented as an illustration. The result obtained in other operating environments may vary. Lenovo may use or distribute any of the information you supply in any way it believes appropriate without incurring any obligation to you.

Any references in this publication to non-Lenovo Web sites are provided for convenience only and do not in any manner serve as an endorsement of those Web sites. The materials at those Web sites are not part of the materials for this Lenovo product, and use of those Web sites is at your own risk. Any performance data contained herein was determined in a controlled environment. Therefore, the result obtained in other operating environments may vary significantly. Some measurements may have been made on development-level systems and there is no guarantee that these measurements will be the same on generally available systems. Furthermore, some measurements may have been estimated through extrapolation. Actual results may vary. Users of this document should verify the applicable data for their specific environment.

© Copyright Lenovo 2023. All rights reserved.

This document, LP1160, was created or updated on June 8, 2023.

Send us your comments in one of the following ways:

- Use the online Contact us review form found at:
<https://lenovopress.lenovo.com/LP1160>
- Send your comments in an e-mail to:
comments@lenovopress.com

This document is available online at <https://lenovopress.lenovo.com/LP1160>.

Trademarks

Lenovo and the Lenovo logo are trademarks or registered trademarks of Lenovo in the United States, other countries, or both. A current list of Lenovo trademarks is available on the Web at <https://www.lenovo.com/us/en/legal/copytrade/>.

The following terms are trademarks of Lenovo in the United States, other countries, or both:

Lenovo®
AnyBay®
Bootable Media Creator
Lenovo Services
RackSwitch
ServerProven®
System x®
ThinkSystem®
TopSeller
TruDDR4
UpdateXpress System Packs
XClarity®

The following terms are trademarks of other companies:

Intel® and Xeon® are trademarks of Intel Corporation or its subsidiaries.

Linux® is the trademark of Linus Torvalds in the U.S. and other countries.

ActiveX®, Microsoft®, Windows Server®, and Windows® are trademarks of Microsoft Corporation in the United States, other countries, or both.

SPECpower® is a trademark of the Standard Performance Evaluation Corporation (SPEC).

Other company, product, or service names may be trademarks or service marks of others.